

# Mitsubishi Programmable Controller

## Analog-Digital Converter Module type AJ65SBT-64AD User's Manual

---

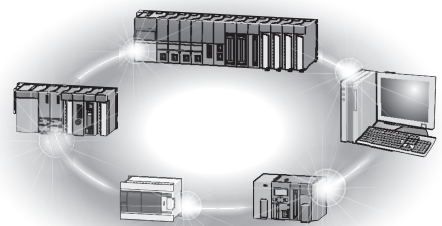



## • SAFETY PRECAUTIONS •

(Read these precautions before using this product.)

Before using this product, please read this manual and the relevant manuals carefully and pay full attention to safety to handle the product correctly.

The precautions given in this manual are concerned with this product. Refer to the user's manual of the CPU module to use for a description of the programmable controller system safety precautions.

In this manual, the safety precautions are classified into two levels: "⚠ WARNING" and "⚠ CAUTION".



Indicates that incorrect handling may cause hazardous conditions, resulting in death or severe injury.



Indicates that incorrect handling may cause hazardous conditions, resulting in minor or moderate injury or property damage.

Under some circumstances, failure to observe the precautions given under "⚠ CAUTION" may lead to serious consequences.

Observe the precautions of both levels because they are important for personal and system safety.

Make sure that the end users read this manual and then keep the manual in a safe place for future reference.

### [Design Precautions]

#### **WARNING**

- In the case of a communication failure in the network, data in the master module are held. Check the communication status information (SB, SW) and configure an interlock circuit in the sequence program to ensure that the entire system will operate safely.

#### **CAUTION**

- Do not install the control lines or communication cables together with the main circuit lines or power cables.  
Keep a distance of 100mm (3.94 inches) or more between them.  
Failure to do so may result in malfunction due to noise.

## [Installation Precautions]

### CAUTION

- Use the programmable controller in an environment that meets the general specifications in this manual.  
Failure to do so may result in electric shock, fire, malfunction, or damage to or deterioration of the product.
- For protection of the switches, do not remove the cushioning material before installation.
- Securely fix the module with a DIN rail or mounting screws. Tighten the screws within the specified torque range.  
Undertightening can cause drop of the screw, short circuit or malfunction.  
Overtightening can damage the screw and/or module, resulting in drop, short circuit, or malfunction.
- Do not directly touch any conductive part of the module.  
Doing so can cause malfunction or failure of the module.

## [Wiring Precautions]

### CAUTION

- Shut off the external power supply for the system in all phases before wiring.  
Failure to do so may result in damage to the product.
- Ground the FG and FG1 terminals to the protective ground conductor dedicated to the programmable controller.  
Failure to do so may result in malfunction.
- Tighten any unused terminal screws within the specified torque range (0.42 to 0.50N•m).  
Failure to do so may cause a short circuit due to contact with a solderless terminal.
- Use applicable solderless terminals and tighten them within the specified torque range.  
If any spade solderless terminal is used, it may be disconnected when the terminal screw comes loose, resulting in failure.
- Check the rated voltage and terminal layout before wiring to the module, and connect the cables correctly.  
Connecting a power supply with a different voltage rating or incorrect wiring may cause a fire or failure.
- Tighten the terminal screw within the specified torque range.  
Undertightening can cause short circuit or malfunction.  
Overtightening can damage the screw and/or module, resulting in drop, short circuit, or malfunction.
- Prevent foreign matter such as dust or wire chips from entering the module.  
Such foreign matter can cause a fire, failure, or malfunction.

## [Wiring Precautions]

### CAUTION

- Place the cables in a duct or clamp them.  
If not, dangling cable may swing or inadvertently be pulled, resulting in damage to the module or cables or malfunction due to poor contact.
- Do not install the control lines or communication cables together with the main circuit lines or power cables. Failure to do so may result in malfunction due to noise.
- When disconnecting the cable from the module, do not pull the cable by the cable part.  
Loosen the screws of connector before disconnecting the cable.  
Failure to do so may result in damage to the module or cable or malfunction due to poor contact.

## [Startup and Maintenance Precautions]

### CAUTION

- Do not touch any terminal while power is on. Doing so may cause malfunction.
- Shut off the external power supply for the system in all phases before cleaning the module or retightening the terminal screws.  
Failure to do so may cause the module to fail or malfunction.  
Undertightening the terminal screws can cause short circuit or malfunction.  
Overtightening can damage the screw and/or module, resulting in drop, short circuit, or malfunction.
- Do not disassemble or modify the modules.  
Doing so may cause failure, malfunction, injury, or a fire.
- Do not drop or apply strong shock to the module. Doing so may damage the module.
- Shut off the external power supply for the system in all phases before mounting or removing the module to or from the panel.  
Failure to do so may cause the module to fail or malfunction.
- After the first use of the product, do not mount/remove the terminal block to/from the module more than 50 times. (IEC 61131-2 compliant)
- Before handling the module, touch a grounded metal object to discharge the static electricity from the human body.  
Failure to do so may cause the module to fail or malfunction.

## [Disposal Precautions]

### CAUTION

- When disposing of this product, treat it as industrial waste.

## • CONDITIONS OF USE FOR THE PRODUCT •

- (1) Mitsubishi programmable controller ("the PRODUCT") shall be used in conditions;
- i) where any problem, fault or failure occurring in the PRODUCT, if any, shall not lead to any major or serious accident; and
  - ii) where the backup and fail-safe function are systematically or automatically provided outside of the PRODUCT for the case of any problem, fault or failure occurring in the PRODUCT.

- (2) The PRODUCT has been designed and manufactured for the purpose of being used in general industries.

MITSUBISHI SHALL HAVE NO RESPONSIBILITY OR LIABILITY (INCLUDING, BUT NOT LIMITED TO ANY AND ALL RESPONSIBILITY OR LIABILITY BASED ON CONTRACT, WARRANTY, TORT, PRODUCT LIABILITY) FOR ANY INJURY OR DEATH TO PERSONS OR LOSS OR DAMAGE TO PROPERTY CAUSED BY the PRODUCT THAT ARE OPERATED OR USED IN APPLICATION NOT INTENDED OR EXCLUDED BY INSTRUCTIONS, PRECAUTIONS, OR WARNING CONTAINED IN MITSUBISHI'S USER, INSTRUCTION AND/OR SAFETY MANUALS, TECHNICAL BULLETINS AND GUIDELINES FOR the PRODUCT.

("Prohibited Application")

Prohibited Applications include, but not limited to, the use of the PRODUCT in;

- Nuclear Power Plants and any other power plants operated by Power companies, and/or any other cases in which the public could be affected if any problem or fault occurs in the PRODUCT.
- Railway companies or Public service purposes, and/or any other cases in which establishment of a special quality assurance system is required by the Purchaser or End User.
- Aircraft or Aerospace, Medical applications, Train equipment, transport equipment such as Elevator and Escalator, Incineration and Fuel devices, Vehicles, Manned transportation, Equipment for Recreation and Amusement, and Safety devices, handling of Nuclear or Hazardous Materials or Chemicals, Mining and Drilling, and/or other applications where there is a significant risk of injury to the public or property.

Notwithstanding the above, restrictions Mitsubishi may in its sole discretion, authorize use of the PRODUCT in one or more of the Prohibited Applications, provided that the usage of the PRODUCT is limited only for the specific applications agreed to by Mitsubishi and provided further that no special quality assurance or fail-safe, redundant or other safety features which exceed the general specifications of the PRODUCTS are required. For details, please contact the Mitsubishi representative in your region.

REVISIONS

\* The manual number is given on the bottom left of the back cover.

Print Date	* Manual Number	Revision
Oct., 2000	SH (NA)-080106-A	First printing
Jun., 2003	SH (NA)-080106-B	Program example correction <div style="border: 1px solid black; padding: 2px;">Correction</div> SAFETY PRECAUTIONS, About Manuals, Conformation to the EMC Directive and Low Voltage Instruction, About the Generic Terms and Abbreviations, Chapter 1, Section 2.1, 2.2, 3.1, 3.2, 3.3.5, 3.5.2, 4.1, 4.7.2, Appendix 1
Mar., 2005	SH (NA)-080106-C	<div style="border: 1px solid black; padding: 2px;">Addition</div> Section 2.3 <div style="border: 1px solid black; padding: 2px;">Correction</div> SAFETY PRECAUTIONS, About Manuals, Section 3.1, 4.2, Appendix 2
Mar., 2006	SH (NA)-080106-D	<div style="border: 1px solid black; padding: 2px;">Correction</div> REVISIONS, Section 2.3
Jan., 2007	SH (NA)-080106-E	<div style="border: 1px solid black; padding: 2px;">Correction</div> SAFETY PRECAUTIONS, Section 4.3, 5.3, Appendix 2
Sep., 2010	SH (NA)-080106-F	<div style="border: 1px solid black; padding: 2px;">Correction</div> SAFETY PRECAUTIONS, Compliance with the EMC and Low Voltage Directives, About the Generic Terms and Abbreviations, Chapter 1, Section 2.2, 3.1, 3.2, 3.3, 4.2, 4.3, 4.8.4, 4.9, 5.2, 5.3, 6.2, 6.3, Appendix 1, Appendix 2  <div style="border: 1px solid black; padding: 2px;">Addition</div> CONDITIONS OF USE FOR THE PRODUCT  <div style="border: 1px solid black; padding: 2px;">Deletion</div> Section 4.7.1
Oct., 2014	SH (NA)-080106-G	<div style="border: 1px solid black; padding: 2px;">Correction</div> ABOUT MANUALS, COMPLIANCE WITH EMC AND LOW VOLTAGE DIRECTIVES, Section 2.2, 3.1, 3.2, 3.3.5, 4.2, 4.3, 4.5, Chapter 5, Section 5.2, 5.3, 6.1, 6.2, 6.3, Appendix 2  <div style="border: 1px solid black; padding: 2px;">Addition</div> ABOUT THE GENERIC TERMS AND ABBREVIATIONS, Section 2.4

Japanese Manual Version SH-080087-I

This manual confers no industrial property rights or any rights of any other kind, nor does it confer any patent licenses. Mitsubishi Electric Corporation cannot be held responsible for any problems involving industrial property rights which may occur as a result of using the contents noted in this manual.

© 2000 MITSUBISHI ELECTRIC CORPORATION

## INTRODUCTION

Thank you for choosing a Mitsubishi MELSEC-A Series General Purpose Programmable Controller. Before using your new PLC, please read this manual thoroughly to gain an understanding of its functions so you can use it properly.

## CONTENTS

SAFETY PRECAUTIONS .....	A- 1
CONDITIONS OF USE FOR THE PRODUCT .....	A- 4
REVISIONS .....	A- 5
INTRODUCTION .....	A- 6
ABOUT MANUALS .....	A- 8
COMPLIANCE WITH EMC AND LOW VOLTAGE DIRECTIVES .....	A- 8
ABOUT THE GENERIC TERMS AND ABBREVIATIONS .....	A- 9
PRODUCT COMPONENTS .....	A-10

<b>1. OVERVIEW</b>	<b>1- 1 to 1- 2</b>
--------------------	---------------------

1.1 Features.....	1- 1
-------------------	------

<b>2. SYSTEM CONFIGURATION</b>	<b>2- 1 to 2- 4</b>
--------------------------------	---------------------

2.1 Overall Configuration .....	2- 1
2.2 Applicable System.....	2- 2
2.3 Checking Hardware Version .....	2- 3
2.4 Checking Serial Number .....	2- 3

<b>3 SPECIFICATION</b>	<b>3- 1 to 3- 16</b>
------------------------	----------------------

3.1 General Specification .....	3- 1
3.2 Performance Specification .....	3- 2
3.3 I/O Conversion Characteristics .....	3- 3
3.3.1 Voltage input characteristics .....	3- 4
3.3.2 Current input characteristics .....	3- 5
3.3.3 Relationship between the offset/gain setting and digital output value.....	3- 6
3.3.4 Accuracy .....	3- 6
3.3.5 Conversion speed .....	3- 7
3.4 Function List .....	3- 8
3.4.1 Sampling processing .....	3- 9
3.4.2 Moving average processing .....	3- 9
3.5 Remote I/O Signals .....	3- 10
3.5.1 Remote I/O signal list.....	3- 10
3.5.2 Functions of the remote I/O signals.....	3- 11
3.6 Remote Register .....	3- 13
3.6.1 Remote register allocation .....	3- 13
3.6.2 A/D conversion enable/prohibit specification (Address RWwm).....	3- 14
3.6.3 Input range setting (Address RWwm+1).....	3- 15
3.6.4 Moving average processing count setting (Address RWwm+2) .....	3- 16



3.6.5 CH. □ Digital output value (Address RWrn to RWrn+3)..... 3- 16

<b>4 SETUP AND PREPARATION BEFORE OPERATION</b>	<b>4- 1 to 4- 10</b>
---	----------------------

4.1 Pre-Operation Procedure.....	4- 1
4.2 Precautions When Handling .....	4- 1
4.3 Name of Each Part.....	4- 3
4.4 Offset/Gain Setting.....	4- 5
4.5 Station Number Setting.....	4- 7
4.6 Facing Direction of the Module Installation .....	4- 7
4.7 Data Link Cable Wiring .....	4- 8
4.7.1 Connection of the CC-Link dedicated cables .....	4- 8
4.8 Wiring.....	4- 9
4.8.1 Wiring precautions.....	4- 9
4.8.2 Module connection example .....	4- 9
4.9 Maintenance and Inspection.....	4- 10

<b>5 PROGRAMMING</b>	<b>5- 1 to 5- 16</b>
----------------------	----------------------

5.1 Programming Procedure.....	5- 1
5.2 Conditions of Program Example .....	5- 2
5.3 Program Example for Use of the QCPU (Q mode).....	5- 4
5.4 Program Example for Use of the QnACPU .....	5- 8
5.5 Program Example for Use of the ACPU/QCPU (A mode) (dedicated instructions) .....	5- 11
5.6 Program Example for Use of the ACPU/QCPU (A mode) (FROM/TO instructions) .....	5- 14

<b>6 TROUBLESHOOTING</b>	<b>6- 1 to 6- 6</b>
--------------------------	---------------------

6.1 Using the Remote Input Signals to Check Errors .....	6- 1
6.2 Using the LED Indications to Check Errors.....	6- 2
6.3 When the digital output value cannot be read.....	6- 4
6.4 Troubleshooting for the Case where the "ERR." LED of the Master Station Flickers .....	6- 5

<b>APPENDICES</b>	<b>APP- 1 to APP- 4</b>
-------------------	-------------------------

Appendix 1 Comparison between This Product and Conventional Product .....	APP- 1
Appendix 2 External Dimensions.....	APP- 3

<b>INDEX</b>	<b>Index- 1 to Index- 3</b>
--------------	-----------------------------

## ABOUT MANUALS

The following manuals are also related to this product.  
In necessary, order them by quoting the details in the tables below.

### **Related Manuals**

Manual Name	Manual Number (Model Code)
CC-Link System Master/Local Module User's Manual Type AJ61BT11/A1SJ61BT11 Describes the system configuration, performance specifications, functions, handling, wiring and troubleshooting of the AJ61BT11 and A1SJ61BT11. (Sold separately)	IB-66721 (13J872)
CC-Link System Master/Local Module User's Manual Type AJ61QBT11/A1SJ61QBT11 Describes the system configuration, performance specifications, functions, handling, wiring and troubleshooting of the AJ61QBT11 and A1SJ61QBT11. (Sold separately)	IB-66722 (13J873)
MELSEC-Q CC-Link System Master/Local Module User's Manual Describes the system configuration, performance specifications, functions, handling, wiring and troubleshooting of the QJ61BT11. (Sold separately)	SH-080394E (13JR64)
MELSEC-L CC-Link System Master/Local Module User's Manual Describes the system configuration, performance specifications, functions, handling, wiring, and troubleshooting of the LCPU with built-in CC-Link and LJ61BT11. (Sold separately)	SH-080895ENG (13JZ41)
MELSEC iQ-R CC-Link System Master/Local Module User's Manual (Application) Describes functions, parameter settings, programming, troubleshooting, I/O signals, and buffer memory of the CC-Link system master/local module. (Sold separately)	SH-081270ENG (13JX19)
Type AnSHCPU/AnACPU/AnUCPU/QCPU-A (A Mode) Programming Manual (Dedicated Instructions) Describes the instructions extended for the AnSHCPU/AnACPU/AnUCPU/QCPU-A (A Mode). (Sold separately)	IB-66251 (13J742)

## COMPLIANCE WITH EMC AND LOW VOLTAGE DIRECTIVES

### (1) Method of ensuring compliance

To ensure that Mitsubishi programmable controllers maintain EMC and Low Voltage Directives when incorporated into other machinery or equipment, certain measures may be necessary. Please refer to one of the following manuals.

- User's manual for the CPU module or head module used
- Safety Guidelines

(This manual is included with the CPU module, base unit, or head module.)

The CE mark on the side of the programmable controller indicates compliance with EMC and Low Voltage Directives.

### (2) Additional measures

To ensure that this product maintains EMC and Low Voltage Directives, please refer to one of the manuals listed under (1).

## ABOUT THE GENERIC TERMS AND ABBREVIATIONS

Unless otherwise specified, the following generic terms and abbreviations are used in this manual to describe Type AJ65SBT-64AD analog-digital converter module.

Generic Term/Abbreviation	Description
GX Developer	Product name of the software package for the MELSEC programmable controllers
GX Works2	
ACPU	Generic term for A0J2CPU, A0J2HCPU, A2CPU, A2CPU-S1, A3CPU, A1SCPU, A1SCPU-S1, A1SCPUC-24-R2, A1SHCPU, A1SJCPU, A1SJCPU-S3, A1SJHCPU, A1NCP, A2NCP, A2NCP-S1, A3NCP, A3MCP, A3HCP, A2SCP, A2SCP-S1, A2SHCP, A2SHCP-S1, A2ACP, A2ACP-S1, A3ACP, A2UCP, A2UCP-S1, A2ASCP, A2ASCP-S1, A2ASCP-S30, A2USHCP-S1, A3UCP, A4UCP
QnACPU	Generic term for Q2ACP, Q2ACP-S1, Q2ASCP, Q2ASCP-S1, Q2ASHCP, Q2ASHCP-S1, Q3ACP, Q4ACP, Q4ARCP
QCPU (A mode)	Generic term for Q02CPU-A, Q02HCP-A, Q06HCP-A
QCPU (Q mode)	Generic term for Q00JCP, Q00UJCP, Q00CP, Q00UCP, Q01CP, Q01UCP, Q02CP, Q02HCP, Q02PHCP, Q02UCP, Q03UDCP, Q03UDECP, Q03UDVCP, Q04UDHCP, Q04UDEHCP, Q04UDVCP, Q06HCP, Q06PHCP, Q06UDHCP, Q06UDEHCP, Q06UDVCP, Q10UDHCP, Q10UDEHCP, Q12HCP, Q12PHCP, Q12PRHCP, Q13UDHCP, Q13UDEHCP, Q13UDVCP, Q20UDHCP, Q20UDEHCP, Q25HCP, Q25PHCP, Q25PRHCP, Q26UDHCP, Q26UDEHCP, Q26UDVCP, Q50UDEHCP, and Q100UDEHCP
LCPU	Generic term for L02SCP, L02SCP-P, L02CP, L02CP-P, L06CP, L06CP-P, L26CP, L26CP-P, L26CP-BT, and L26CP-PBT
RCPU	Generic term for R04CP, R08CP, R16CP, R32CP, and R120CP
Master station	Station that controls the data link system. One master station is required for each system.
Local station	Station having a PLC CPU and the ability to communicate with the master and other local stations.
Remote I/O station	Remote station that handles bit unit data only. (Performs input and output with external devices.) (AJ65BTB1-16D, AJ65SBTB1-16D)
Remote device station	Remote station that handles bit unit and word unit data only. (Performs input and output with external devices, and analog data exchange.)
Remote station	Generic term for remote I/O station and remote device station (Controlled by the master station)
Intelligent device station	Station that can perform transient transmission, such as the AJ65BT-R2N (including local stations).
Master module	Generic term for modules that can be used as the master station
SB	Link special relay (for CC-Link) Bit unit information that indicates the module operating status and data link status of the master station/local station.
SW	Link special register (for CC-Link) 16 bit unit information that indicates the module operating status and data link status of the master station/local station.
RX	Remote input (for CC-Link) Information entered in bit units from the remote station to the master station.
RY	Remote output (for CC-Link) Information output in bit units from the master station to the remote station.
RWw	Remote register (Write area for CC-Link) Information output in 16-bit units from the master station to the remote device station.
RWr	Remote register (Read area for CC-Link) Information entered in 16-bit units from the remote device station to the master station.

PRODUCT COMPONENTS

This product consists of the following.

Product Name	Quantity
Type AJ65SBT-64AD analog-digital converter module	1
Type AJ65SBT-64AD analog-digital converter module user's manual (hardware)	1

## 1 OVERVIEW

This user's manual explains the specifications, handling, programming methods and others of Type AJ65SBT-64AD analog-digital converter module (hereafter abbreviated to the "AJ65SBT-64AD") which is used as a remote device station of a CC-Link system. The AJ65SBT-64AD converts the analog signals (voltage or current input) from the programmable controller external source to a 16-bit encoded binary data digital value.

### 1.1 Features

This section gives the features of the AJ65SBT-64AD.

(1) **High accuracy**

This module performs A/D conversion at the accuracy of  $\pm 0.4\%$  relative to the maximum value of the digital output value at the operating ambient temperature of 0 to 55°C, or at  $\pm 0.2\%$  relative to the maximum value of the digital output value at the operating ambient temperature of 25 $\pm$ 5°C.

(2) **Input range selectable per channel**

You can choose the analog input range per channel to change the I/O conversion characteristics.

(3) **High resolution of 1/ $\pm$ 4000**

By changing the input range, you can choose and set the digital value resolution to either 1/4000 or 1/ $\pm$ 4000 (when the -10 to +10V range or user range setting 1 is selected) to provide high-resolution digital values.

(4) **Designation of sampling processing or moving average processing**

As a conversion method, you can specify sampling processing or moving average processing per channel.

(5) **Smaller than the conventional A/D converter module**

This module is 60% smaller in installation area and 38% less in volume than the conventional CC-Link A/D converter module (AJ65BT-64AD).

(6) **Up to 42 modules connectable**

You can connect up to 42 AJ65SBT-64AD modules to one master station.



## 2 SYSTEM CONFIGURATION

This chapter describes the system configuration for use of the AJ65SBT-64AD.

### 2.1 Overall Configuration

The overall configuration for use of the AJ65SBT-64AD is shown below.

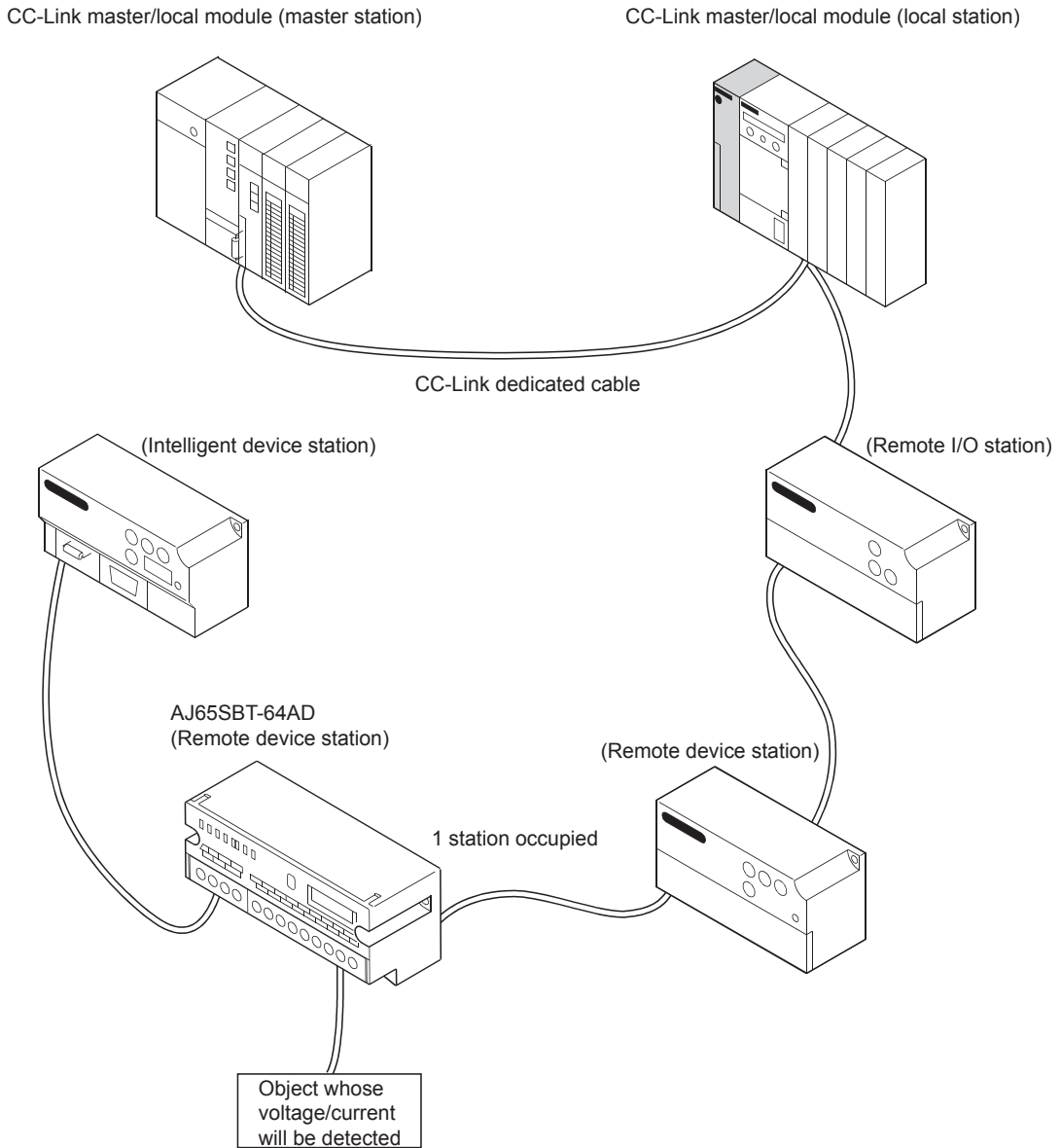

## 2.2 Applicable System

This section explains the applicable system.

### (1) Applicable master modules

For available master modules, visit the CC-Link Partner Association (CLPA) website at:

[www.cc-link.org](http://www.cc-link.org)

#### REMARK

Check the specifications of the master module before use.

### (2) Restrictions on use of CC-Link dedicated instructions (RLPA, RRPA)

The CC-Link dedicated instructions may not be used depending on the programmable controller CPU and master module used.

For details of the restrictions, refer to the A series master module user's manual, and the Programming Manual type AnSHCPU/AnACPU/AnUCPU/QCPU (A mode) (Dedicated Instructions).

This module does not allow the use of the dedicated instructions other than RLPA and RRPA.

Refer to Section 5.5 for a program example using the dedicated instructions (RLPA, RRPA).



### 2.3 Checking Hardware Version

The hardware version of the AJ65SBT-64AD can be checked on the DATE section on the rating plate.

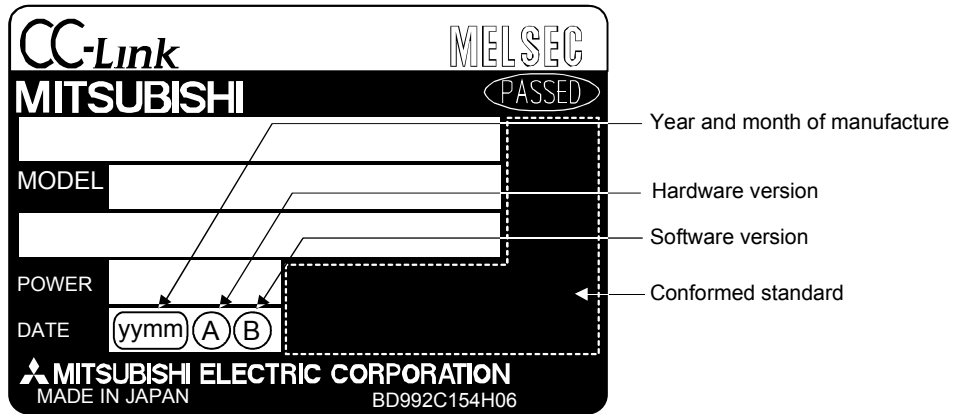

### 2.4 Checking Serial Number

The serial number of the AJ65SBT-64AD can be checked on the SERIAL section on the rating plate.

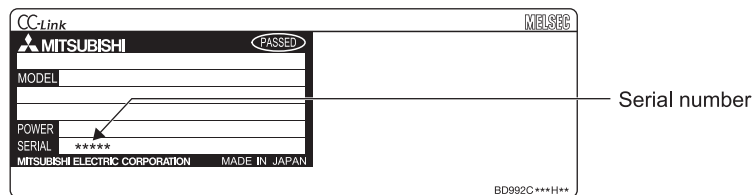



## 3 SPECIFICATION

This chapter provides the specifications of the AJ65SBT-64AD.

## 3.1 General Specification

Table 3.1 indicates the general specifications of the AJ65SBT-64AD.

Table 3.1 General specification

Item	Specification					
Usage ambient temperature	0 to 55°C					
Storage ambient temperature	-20 to 75°C					
Usage ambient humidity	10 to 90% RH, non-condensing					
Storage ambient humidity						
Vibration durability	Compliant with JIS B 3502 and IEC 61131-2	Under intermittent vibration	Frequency	Acceleration	Amplitude	Sweep count 10 times each in X, Y, Z directions
			5 to 8.4Hz	—	3.5mm (0.14 inch)	
		Under continuous vibration	8.4 to 150Hz	9.8m/s <sup>2</sup>	—	—
			5 to 8.4Hz	—	1.75mm (0.069 inch)	
Shock durability	Compliant with JIS B 3502 and IEC 61131-2 (147 m/s <sup>2</sup> , 3 times each in 3 directions X, Y, Z)					
Operating atmosphere	No corrosive gases					
Operating altitude <sup>3</sup>	0 to 2000m					
Installation location	Inside a control panel					
Overvoltage category <sup>1</sup>	Less than II					
Pollution level <sup>2</sup>	Less than 2					

\*1 This indicates the section of the power supply to which the equipment is assumed to be connected between the public electrical power distribution network and the machinery within premises.  
Category II applies to equipment for which electrical power is supplied from fixed facilities.  
The surge voltage withstand level for up to the rated voltage of 300V is 2500V.

\*2 This index indicates the degree to which conductive material is generated in terms of the environment in which the equipment is used.  
Pollution level 2 is when only non-conductive pollution occurs. A temporary conductivity caused by condensing must be expected occasionally.

\*3 Do not use or store the programmable controller under pressure higher than the atmospheric pressure of altitude 0m.  
Doing so may cause malfunction. When using the programmable controller under pressure, please consult your local Mitsubishi representative.

## 3.2 Performance Specification

Table 3.2 indicates the performance specifications of the AJ65SBT-64AD.

Table 3.2 Performance specification

Item		Specification					
Analog input	Voltage	-10 to 10V DC (input resistance 1MΩ)					
	Current	0 to 20mA DC (input resistance 250Ω)					
Digital output		16-bit signed binary (-4096 to 4095)					
I/O characteristics, maximum resolution, accuracy* <sup>1</sup> (accuracy relative to maximum value of digital output value)		Analog input range	Digital output	Accuracy		Max. Resolution	
				Ambient temperature 0 to 55°C	Ambient temperature 25±5°C		
		Voltage	-10 to 10V	-4000 to +4000	±0.4% (±16 digit* <sup>2</sup> )	±0.2% (±8 digit* <sup>2</sup> )	2.5mV
			User range setting 1 (-10 to 10V)				
			0 to 5V	0 to 4000			1.25mV
			1 to 5V				1.0mV
		Current	0 to 20mA	0 to 4000	±0.4% (±16 digit* <sup>2</sup> )	±0.2% (±8 digit* <sup>2</sup> )	5μA
			4 to 20mA				4μA
			User range setting 3 (0 to 20mA)				
		Factory setting is -10 to 10V.					
Maximum conversion speed		1ms/channel					
Absolute maximum input		Voltage ±15 V, current ±30mA* <sup>3</sup>					
Analog input points		4 channels/1 module					
CC-Link station type		Remote device station					
Number of occupied stations		1 station					
Communication cable		CC-Link dedicated cable					
Dielectric withstand voltage		Between power supply/communication system batch and analog input batch: 500VAC, 1 minute					
Isolation system		Across communication system terminals and all analog input terminals: Photocoupler isolated Across power supply system terminals and all analog input terminals: Photocoupler isolated Across channels: Non-isolated					
Noise immunity		By noise simulator of 500Vp-p noise voltage, 1μs noise width and 25 to 60Hz noise frequency					
External connection	Communication area, module power supply	7-point 2-piece terminal block [transmission circuit, module power supply, FG] M3 × 5.2 Tightening torque: 0.59 to 0.88N·m Applicable solderless terminals: 2 max.					
	I/O area	Direct-coupled, 18-point terminal block [analog input area] M3 × 5.2 Tightening torque: 0.59 to 0.88N·m Applicable solderless terminals: 2 max.					
Applicable wire size		0.3 to 0.75mm <sup>2</sup>					
Applicable solderless terminals		RAV1.25-3 (conforming to JIS C 2805) [Applicable wire size: 0.3 to 1.25mm <sup>2</sup> ] V2-MS3, RAP2-3SL, TGV2-3N [Applicable wire size: 1.25 to 2.0mm <sup>2</sup> ]					
Module mounting screw		M4 screw × 0.7mm × 16mm or more (tightening torque range: 0.78 to 1.08N·m) Can also be mounted to DIN rail					
Supported DIN rail		TH35-7.5Fe, TH35-7.5Al (conforming to IEC 60715)					
External supply power		24V DC (20.4 to 26.4V DC)					
		Inrush current: 8.5A, within 2.3ms					
		Current consumption: 0.090A (at 24VDC)					
Weight		0.20kg					

\*1 For the details of the I/O conversion characteristic, refer to Section 3.3.

\*2 digit indicates digital value

\*3 Current value indicates value of instant input current that does not break module inner electrical resistance.

### 3.3 I/O Conversion Characteristics

The I/O characteristics is the slope created by connecting the offset and gain values, with a straight line when converting the analog signals (voltage or current input) from an external source of the programmable controller to digital values.

The offset value is an analog input value (voltage or current) at which the digital output value is 0.

The gain value is an analog input value (voltage or current) at which the digital output value is 4000.

3.3.1 Voltage input characteristics

The voltage input characteristic graph is shown below.

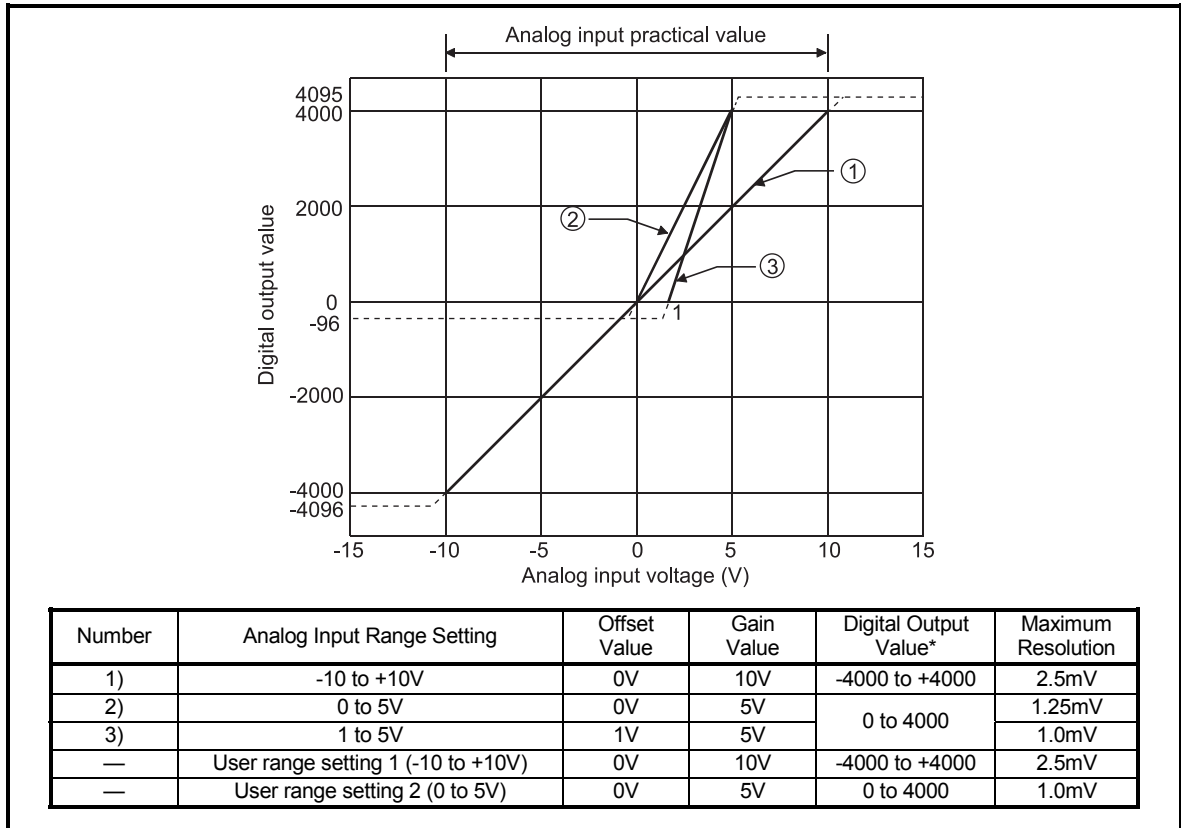

Fig. 3.1 Voltage Input Characteristic

<b>POINT</b>
<p>(1) Do not input more than ±15V. The element may be damaged.</p> <p>(2) If the analog input provided corresponds to the digital output value* beyond its range, the digital output value is fixed to the maximum or minimum.</p> <ul style="list-style-type: none"> <li>• For 0 to 4000, the digital output value is within the range -96 to 4095.</li> <li>• For -4000 to +4000, the digital output value is within the range -4096 to +4095.</li> </ul> <p>(3) Within the analog input and digital output scopes of each input range, the maximum resolution and accuracy are within the performance specification range. Outside those scopes, however, they may not fall within the performance specification range. (Avoid using the dotted line part in Fig. 3.1.)</p> <p>(4) Set the offset and gain values of the user range setting within the range satisfying the following conditions.</p> <p>(a) Setting range when user range setting 1 is selected: -10 to +10V</p> <p>(b) Setting range when user range setting 2 is selected: 0 to 5V</p> <p>(c) (Gain value) &gt; (Offset value)</p> <p>If you attempt to make setting outside the setting range of (a) or (b), the "RUN" LED flickers at 0.5s intervals. Set the values within the setting range.</p> <p>If you attempt to make setting outside the setting range of (c), the "RUN" LED flickers at 0.5s intervals. Make setting again.</p>

3.3.2 Current input characteristics

The current input characteristic graph is shown below.

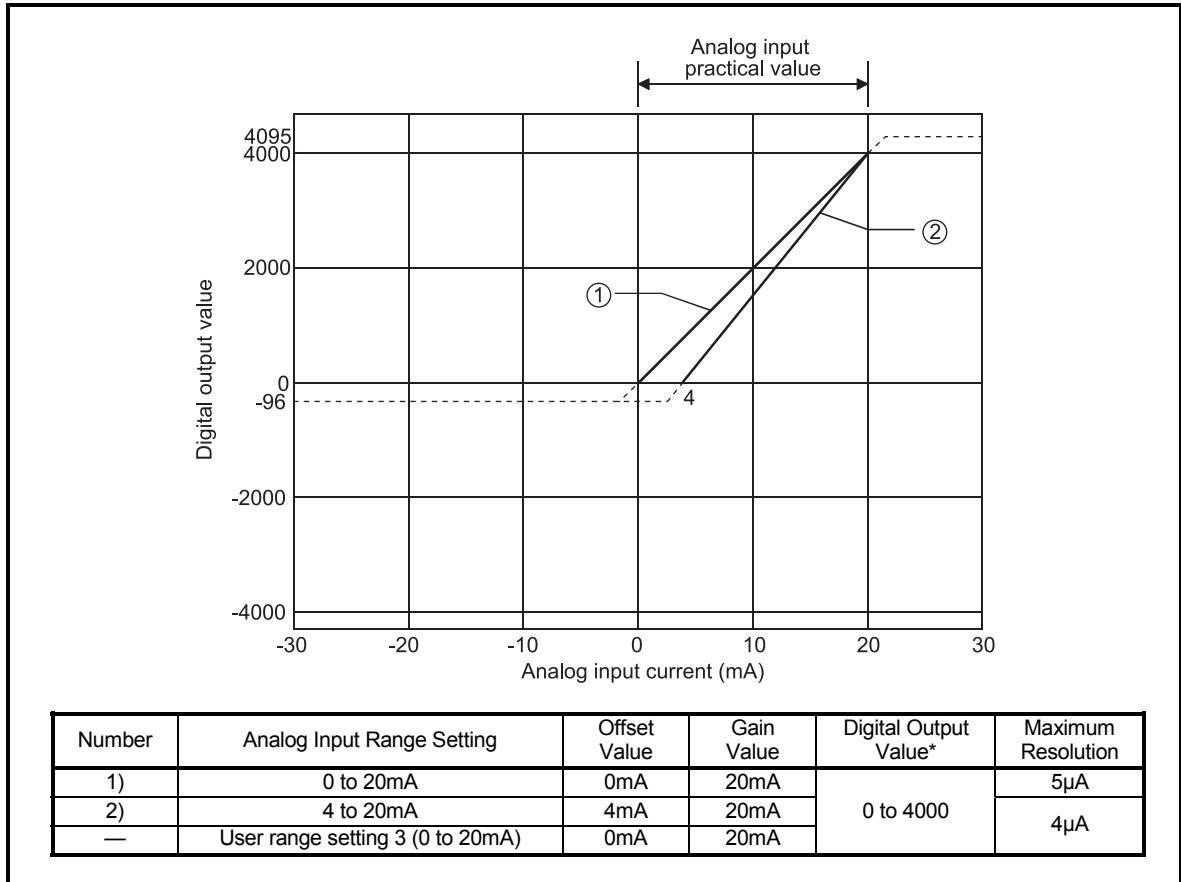

Fig. 3.2 Current Input Characteristic

POINT
(1) Do not input more than $\pm 30$ mA. A breakdown may result due to heat increase.
(2) If the analog input provided corresponds to the digital output value* beyond its range, the digital output value is fixed to the maximum or minimum. <ul style="list-style-type: none"> <li>• For 0 to 4000, the digital output value is within the range -96 to 4095.</li> </ul>
(3) Within the analog input and digital output scopes of each input range, the maximum resolution and accuracy are within the performance specification range. Outside those scopes, however, they may not fall within the performance specification range. (Avoid using the dotted line part in Fig. 3.2.)
(4) Set the offset and gain values of the user range setting within the range satisfying the following conditions. <ul style="list-style-type: none"> <li>(a) Setting range when user range setting 3 is selected: 0 to 20mA</li> <li>(b) (Gain value) &gt; (Offset value)</li> </ul> If you attempt to make setting outside the setting range of (a), the "RUN" LED flickers at 0.5s intervals. Set the values within the setting range. If you attempt to make setting outside the setting range of (b), the "RUN" LED flickers at 0.5s intervals. Make setting again.

### 3.3.3 Relationship between the offset/gain setting and digital output value

The relationship between the offset/gain setting and digital output value is described.

#### (1) Resolution

The resolution is obtained by the following formula:

(a) For the voltage input:

$$\text{Resolution} = \frac{(\text{Gain value}) - (\text{Offset value})}{4000}$$

(b) For the current input:

$$\text{Resolution} = \frac{(\text{Gain value}) - (\text{Offset value})}{4000}$$

#### (2) Relationship between the maximum resolution and digital output value

The maximum resolution of the AJ65SBT-64AD is as indicated in the performance specification.

If the following is satisfied from the offset/gain setting, the digital output value does not increase/decrease by one.

$$\frac{(\text{Gain value}) - (\text{Offset value})}{4000} < \text{Maximum resolution}$$

### 3.3.4 Accuracy

Accuracy is relative to the maximum value of the digital output value.

If you change the offset/gain setting or input range to change the input characteristic, accuracy does not change and is held within the range indicated in the performance specifications.

Accuracy is within  $\pm 0.2\%$  ( $\pm 8$  digit) at the operating ambient temperature of  $25 \pm 5^\circ\text{C}$  or within  $\pm 0.4\%$  ( $\pm 16$  digit) at the operating ambient temperature of  $0$  to  $55^\circ\text{C}$ .

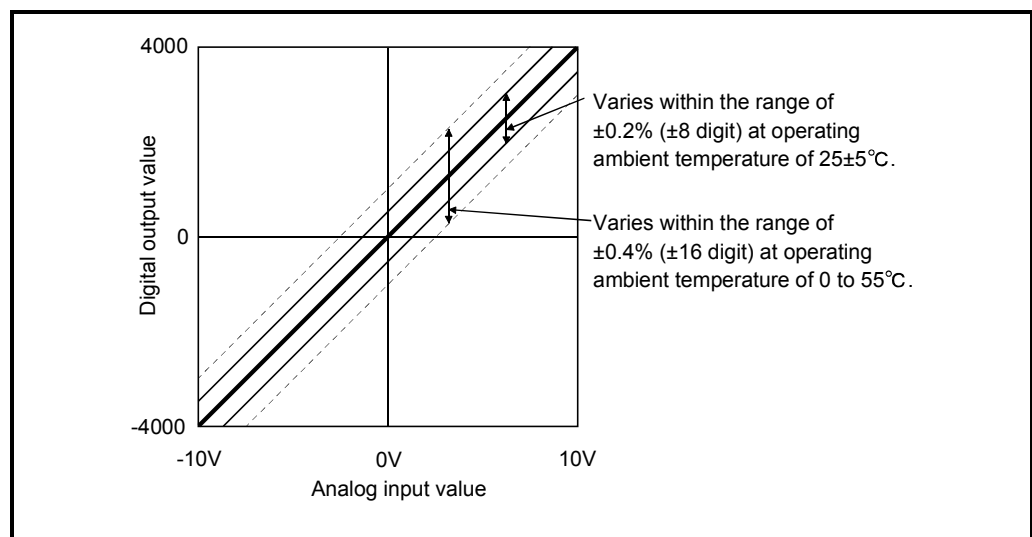

Fig. 3.3 Voltage Input Characteristic Accuracy



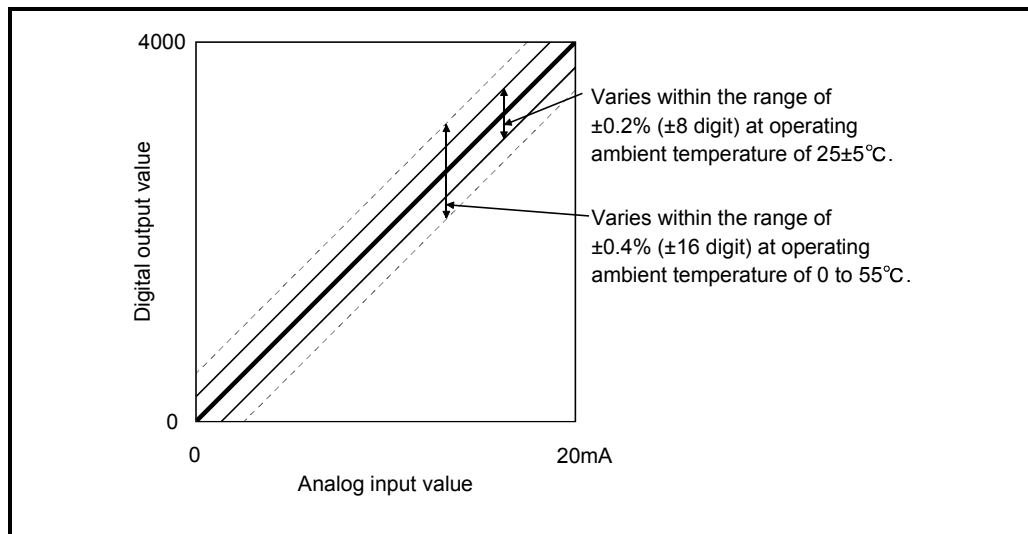

Fig. 3.4 Current Input Characteristic Accuracy

### 3.3.5 Conversion speed

Conversion speed indicates time from channel changing to A/D conversion completion. Conversion speed per channel of the AJ65SBT-64AD is 1ms.

Due to the data link processing time of the CC-Link system, there is a transmission delay until the A/D conversion value is read actually.

For the data link processing time, refer to the user's manual for the master module used.

Example) Data link processing time taken in the asynchronous mode when the master module is the QJ61BT11 (normal value)

[Calculation expression]

$SM + LS \times 1 + \text{remote device station processing time}$

SM: Scan time of master station sequence program

LS : Link scan time

Remote device station processing time:  $(\text{Number of channels used} + 1^*) \times 1\text{ms}$

\*: Internal processing time of AJ65SBT-64AD

## 3.4 Function List

The AJ65SBT-64AD function list is shown in table 3.3.

Table 3.3 AJ65SBT-64AD function list

Item	Description	Reference section																		
Sampling processing	Perform A/D conversion of an analog input value one by one and store the result into the remote register each time.	Section 3.4.1 Section 3.5.2																		
Moving average processing	Average the digital output values of the specified count measured per sampling time.	Section 3.4.2 Section 3.5.2 Section 3.6.4																		
A/D conversion enable/prohibit specification	Specify whether A/D conversion is enabled or disabled per channel. By prohibiting the conversion for the channels which are not used, the sampling time can be shortened.	Section 3.6.2																		
Input range changing function	Can set the analog input range per channel to change the I/O conversion characteristics. Select the input range setting from among the following 8 types. <table border="1" data-bbox="454 817 1197 1131"> <thead> <tr> <th>Input Range</th> <th>Set Value</th> </tr> </thead> <tbody> <tr> <td>-10 to +10V</td> <td>0H</td> </tr> <tr> <td>0 to 5V</td> <td>1H</td> </tr> <tr> <td>1 to 5V</td> <td>2H</td> </tr> <tr> <td>0 to 20mA</td> <td>3H</td> </tr> <tr> <td>4 to 20mA</td> <td>4H</td> </tr> <tr> <td>User range setting 1 (-10 to +10V)</td> <td>5H</td> </tr> <tr> <td>User range setting 2 (0 to 5V)</td> <td>6H</td> </tr> <tr> <td>User range setting 3 (0 to 20mA)</td> <td>7H</td> </tr> </tbody> </table>	Input Range	Set Value	-10 to +10V	0H	0 to 5V	1H	1 to 5V	2H	0 to 20mA	3H	4 to 20mA	4H	User range setting 1 (-10 to +10V)	5H	User range setting 2 (0 to 5V)	6H	User range setting 3 (0 to 20mA)	7H	Section 3.6.3
Input Range	Set Value																			
-10 to +10V	0H																			
0 to 5V	1H																			
1 to 5V	2H																			
0 to 20mA	3H																			
4 to 20mA	4H																			
User range setting 1 (-10 to +10V)	5H																			
User range setting 2 (0 to 5V)	6H																			
User range setting 3 (0 to 20mA)	7H																			
Offset/gain setting	The offset/gain setting can be performed volumeless for each channel, and the I/O conversion characteristics can be changed.	Section 4.4																		

### 3.4.1 Sampling processing

The A/D conversion is performed successively for the analog input, and the converted digital output values are stored in the remote register.

The processing time to store the digital output value into the remote register after the sampling processing differs depending on the number of A/D conversion enabled channels.

$$(\text{Processing time}) = \text{Number of A/D conversion enabled channels} \times 1 \text{ (ms)}$$

↑  
Maximum conversion speed

[Example] When three channels, channels 1, 2, and 3 are enabled for conversion:  
 $3 \times 1 = 3 \text{ (ms)}$

### 3.4.2 Moving average processing

The specified count of digital output values imported per sampling time are averaged to find a value, which is then stored into the remote register.

Since average processing is performed with data shifted per sampling, the most recent digital output value is available.

Average processing can be performed without changing the conversion speed.

Use moving average processing count setting (address RWwm+2) to set the number of moving average processing.

The count can be selected from among four types: 4, 8, 16 and 32 times.

Moving average processing at the count setting of 4 times

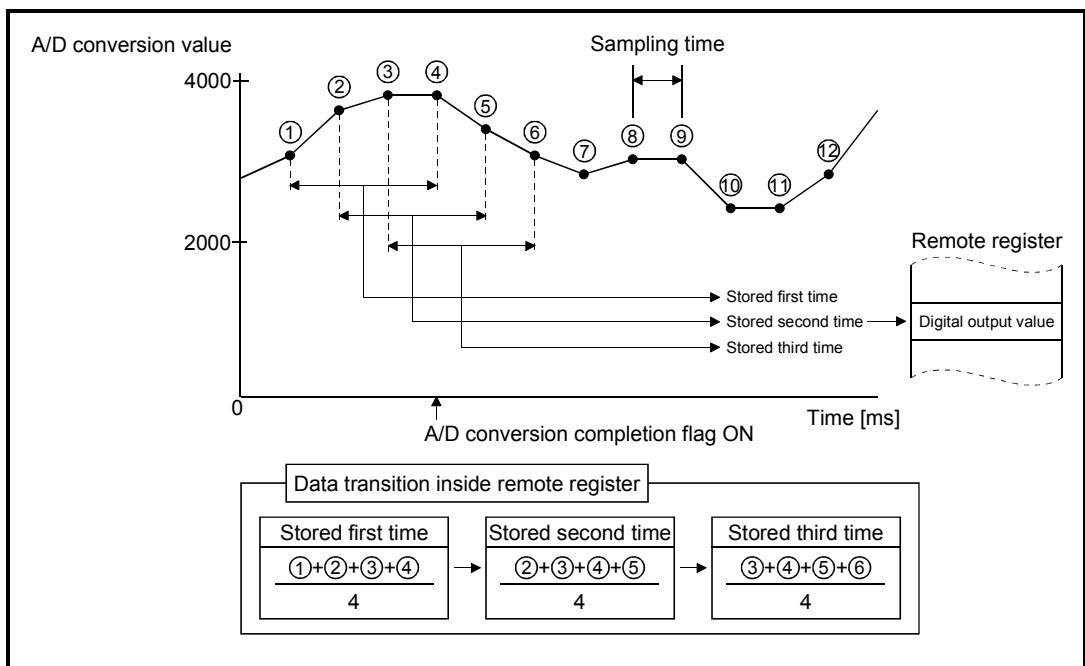

### 3.5 Remote I/O Signals

This section describes the assignment and functions of the remote I/O signals.

#### 3.5.1 Remote I/O signal list

Remote inputs (RX) mean the input signals from the AJ65SBT-64AD to the master module, and remote outputs (RY) mean the output signals from the master module to the AJ65SBT-64AD.

In communications with the master station, the AJ65SBT-64AD uses 32 points of the remote inputs (RX) and 32 points of the remote outputs (RY). Table 3.4 indicates the assignment and names of the remote I/O signals.

Table 3.4 Remote I/O Signals List

Signal direction: AJ65SBT-64AD → Master Module		Signal direction: Master Module → AJ65SBT-64AD	
Remote input (RX)	Signal name	Remote output (RY)	Signal name
RXn0	CH.1 A/D conversion completion flag	RYn0	CH.1 moving average processing specifying flag
RXn1	CH.2 A/D conversion completion flag	RYn1	CH.2 moving average processing specifying flag
RXn2	CH.3 A/D conversion completion flag	RYn2	CH.3 moving average processing specifying flag
RXn3	CH.4 A/D conversion completion flag	RYn3	CH.4 moving average processing specifying flag
RXn4	CH.1 range error flag	RYn4 to RY(n+1)7	Reserved
RXn5	CH.2 range error flag		
RXn6	CH.3 range error flag		
RXn7	CH.4 range error flag		
RXn8 to RXnB	Reserved		
RXnC	E <sup>2</sup> PROM write error flag		
RXnD	Reserved		
RXnE			
RXnF	Test mode flag		
RX(n+1)0 to RX(n+1)7	Reserved		
RX(n+1)8	Initial data processing request flag		
RX(n+1)9	Initial data setting completion flag	RY(n+1)9	Initial data setting request flag
RX(n+1)A	Error status flag	RY(n+1)A	Error reset request flag
RX(n+1)B	Remote READY	RY(n+1)B to RY(n+1)F	Reserved
RX(n+1)C to RX(n+1)F	Reserved		

#### POINT

The reserved devices given in Table 3.4 are used by the system and cannot be used by the user.

If the user has used (turned on/off) any of them, we cannot guarantee the functions of the AJ65SBT-64AD.

3.5.2 Functions of the remote I/O signals

Table 3.5 explains the functions of the remote I/O signals of the AJ65SBT-64AD.

Table 3.5 Remote I/O Signal Details (1/2)

Device No.	Signal Name	Description
RXn0 to RXn3	CH.□ A/D Conversion completion flag	<p>The A/D conversion completion flag turns on at completion of the A/D conversion of the corresponding channel when the initial data setting request flag (RY(n+1)9) turns from off to on after power-on.</p> <p>The A/D conversion completion flag processing is processed only once when the A/D conversion enable/prohibit specification is changed.</p> <ul style="list-style-type: none"> <li>When changing the A/D conversion from prohibit to enable: When the average processing is specified, the flag turns on after completing the average processing of the number of times or time, and storing the A/D conversion digital value in the remote register.</li> <li>When changing the A/D conversion from enable to prohibit: The corresponding channel's A/D conversion completion flag turns off.</li> </ul>
RXn4 to RXn7	CH. □ range error flag	<p>Turns on when the value set for input range setting is outside the setting range.</p> <p>Turns on if all channels are not set to any of "user range settings 1 to 3" at offset/gain setting (in the test mode).</p>
RXnC	E <sup>2</sup> PROM write error flag	<p>Turns on if the number of E<sup>2</sup>PROM write times exceeds its limit (100,000 times per channel). If this flag has turned on, this module itself has failed (hardware fault) and therefore this flag cannot be reset (turned off) by the error reset request flag.</p>
RXnF	Test mode flag	<p>Turns on in the test mode.</p> <p>(Used for interlock to prevent wrong output during offset/gain setting.)</p>
RX(n+1)8	Initial data processing request flag	<p>After power-on, the initial data processing request flag is turned on by the AJ65SBT-64AD to request the initial data to be set.</p> <p>Also, after the initial data processing is complete (initial data processing completion flag RY(n+1)8 ON), the flag is turned off.</p> <p>                     RX(n+1)8□ Initial data processing request flag                      RY(n+1)8□ Initial data processing completion flag                      RX(n+1)9□ Initial data setting completion flag                      RY(n+1)9□ Initial data setting request flag                      RX(n+1)B□ Remote ready                      RXn0 to RXn3□ CH.□ A/D conversion completion flag                 </p> <p>                     ← : Performed by sequence program                      ◀ : Performed by AJ65SBT-64AD                 </p>
RX(n+1)9	Initial data setting completion flag	<p>When the initial data setting request (RY(n+1)9 ON) is made, the flag turns on after the initial data setting completion is done.</p> <p>Also, after the initial data setting is complete, the initial data setting completion flag turns off when the initial data setting request flag turns off.</p>

n: Address allocated to the master module by the station number setting.

Table 3.5 Remote I/O Signal Details (2/2)

Device No.	Signal Name	Description
RX(n+1)A	Error status flag	<p>Turns on when CH. <input type="checkbox"/> range error flag (RXn4 to RXn7) or E<sup>2</sup>PROM write error flag (RXnC) has turned on. Does not turn on at occurrence of the watchdog timer error. ("RUN" LED goes off.)</p> <p> <input type="checkbox"/> RX(n+1)A Error status flag  <input type="checkbox"/> RXn4 to RXn7 CH. <input type="checkbox"/> range error flag  <input type="checkbox"/> RY(n+1)A Error reset request flag                 </p> <p>                     ← : Performed by sequence program                      ← : Performed by AJ65SBT-64AD                 </p>
RX(n+1)B	Remote READY	<p>Turns on when initial data setting is completed after power-on or at termination of the test mode. (Used for interlocking read/write from/to the master module.)</p>
RYn0 to RYn3	CH. <input type="checkbox"/> moving average processing specifying flag	<p>Set the A/D conversion system to sampling processing or moving average processing per channel. Made valid on the leading edge of the initial data setting request flag (RY(n+1)9). OFF: Sampling processing ON: Moving average processing</p>
RY(n+1)8	Initial data processing completion flag	Turns on after initial data processing completion when initial data processing is requested after power-on or test mode operation.
RY(n+1)9	Initial data setting request flag	Turns on at the time of initial data setting or changing.
RY(n+1)A	Error reset request flag	When this flag turns on, the CH. <input type="checkbox"/> range error flag (RXn4 to RXn7) is reset (turned off) and the error status flag (RX(n+1)A) is also reset, but the E <sup>2</sup> PROM write error flag (RXnC) cannot be reset and therefore the error status flag remains on.

n: Address allocated to the master module by the station number setting.

### 3.6 Remote Register

The AJ65SBT-64AD has a remote register for data communication with the master module. The remote register allocation and data structures are described.

#### 3.6.1 Remote register allocation

The remote register allocation is shown in Table 3.6.

Table 3.6 Remote register allocation

Communication direction	Address	Description	Default value	Reference section
Master → Remote	RWwm	A/D conversion enable/prohibit specification	0	Section 3.6.2
	RWwm+1	Input range setting	0	Section 3.6.3
	RWwm+2	Moving average processing count setting	0	Section 3.6.4
	RWwm+3	Reserved	0	—
Remote → Master	RWm	CH.1 digital output value	0	Section 3.6.5
	RWm+1	CH.2 digital output value	0	
	RWm+2	CH.3 digital output value	0	
	RWm+3	CH.4 digital output value	0	

m, n: Address allocated to the master module by the station number setting.

#### POINT

Do not read or write data from or to the reserved area of the remote register. If data is read or written, we cannot guarantee the functions of the AJ65SBT-64AD.

## 3.6.2 A/D conversion enable/prohibit specification (Address RWwm)

- (1) Set whether A/D conversion is enabled or disabled per channel.
- (2) By setting the unused channels to conversion prohibit, the sampling cycle can be shortened.

Example) The sampling cycle when only channels 1 and 3 are set to A/D conversion enabled:

$$2 \text{ (Number of channels enabled)} \times 1\text{ms (Conversion speed at one channel)} = 2\text{ms}$$

- (3) Operation is performed according to the setting made for the leading edges of initial data setting request flag (RY(n+1)9).

- (4) The default setting is A/D conversion disable for all channels.

b15	b14	b13	b12	b11	b10	b9	b8	b7	b6	b5	b4	b3	b2	b1	b0
—	—	—	—	—	—	—	—	—	—	—	—	CH.4	CH.3	CH.2	CH.1
<div style="text-align: center; margin-top: 5px;">Ignored</div>												<div style="text-align: center; margin-top: 5px;">1: Enable A/D conversion 0: Prohibit A/D conversion</div>			



## 3.6.3 Input range setting (Address RWwm+1)

- (1) Set the analog input range per channel.
- (2) Operation is performed according to the setting made for the leading edges of the initial data setting request flag (RY(n+1)9).
- (3) The default setting is -10 to +10V for all channels.

b15	to	b12	b11	to	b8	b7	to	b4	b3	to	b0				
CH.4				CH.3				CH.2				CH.1			

Input Range	Set Value
-10 to +10V	0H
0 to 5V	1H
1 to 5V	2H
0 to 20mA	3H
4 to 20mA	4H
User range setting 1 (-10 to +10V)	5H
User range setting 2 (0 to 5V)	6H
User range setting 3 (0 to 20mA)	7H

- (4) When making offset/gain setting, set all channels to any of "user range settings 1 to 3".  
Setting any other range will result in an error and flicker the "RUN" LED at 0.1s intervals.

3.6.4 Moving average processing count setting (Address RWwm+2)

- (1) Set the average processing count of the channel for which moving average processing has been specified in the CH.  moving average processing specifying flag (RYn0 to RYn3).
- (2) Sampling processing is performed for the channel whose CH.  moving average processing specifying flag (RYn0 to RYn3) was not turned on, independently of the moving average processing count setting.
- (3) Operation is performed according to the setting made for the leading edges of the initial data setting request flag (RY(n+1)9).
- (4) The default setting is 4 times for all channels.  
Bits b2, b3, b6, b7, b10, b11, b14 and b15 are ignored.

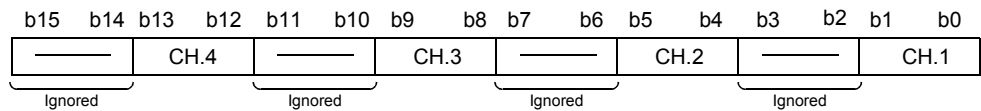

Set Count	Set Value
4 times	0H
8 times	1H
16 times	2H
32 times	3H

3.6.5 CH.  Digital output value (Address RWrn to RWrn+3)

- (1) The digital value after the A/D conversion is stored in the remote register address from RWrn to RWrn+3 for each channel.
- (2) The digital output value is expressed in a 16-bit encoded binary.

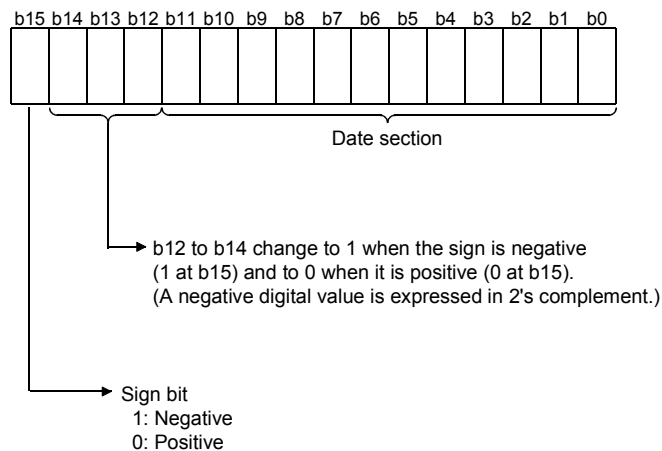

## 4 SETUP AND PREPARATION BEFORE OPERATION

### 4.1 Pre-Operation Procedure

This section explains the preparatory procedure for operating the AJ65SBT-64AD.

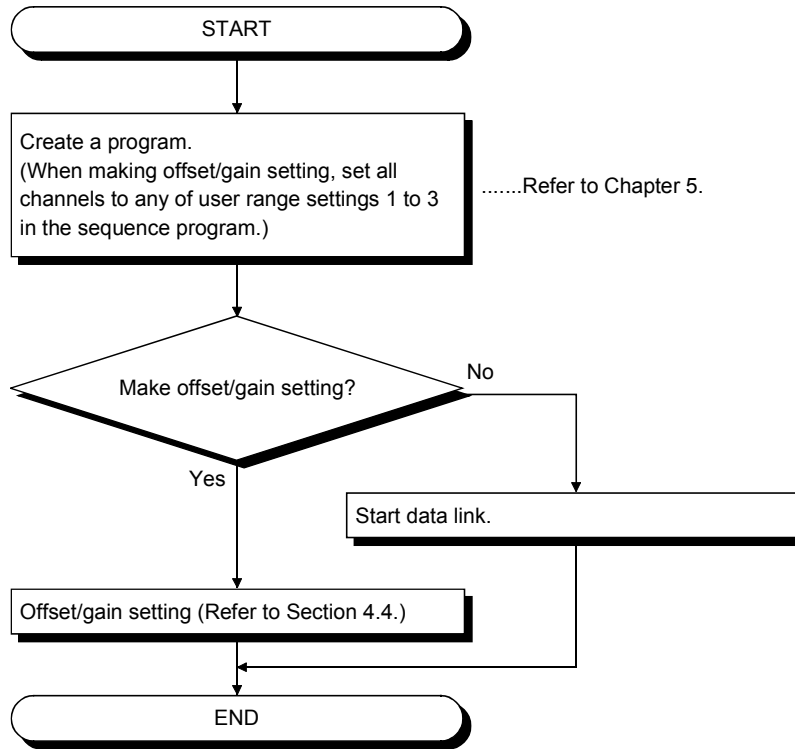

### 4.2 Precautions When Handling

The precautions when handling the AJ65SBT-64AD are described below:

**CAUTION**

- Do not touch any terminal while power is on. Doing so may cause malfunction.
- Prevent foreign matter such as dust or wire chips from entering the module. Such foreign matter can cause a fire, failure, or malfunction.
- Do not disassemble or modify the modules. Doing so may cause failure, malfunction, injury, or a fire.
- Do not directly touch any conductive part of the module. Doing so can cause malfunction or failure of the module.
- Do not drop or apply strong shock to the module. Doing so may damage the module.
- Tighten the terminal screw within the specified torque range. Undertightening can cause short circuit or malfunction. Overtightening can damage the screw and/or module, resulting in drop, short circuit, or malfunction.
- When disposing of this product, treat it as industrial waste.

**CAUTION**

- Use the programmable controller in an environment that meets the general specifications in this manual. Failure to do so may result in electric shock, fire, malfunction, or damage to or deterioration of the product.
- For protection of the switches, do not remove the cushioning material before installation.
- Securely fix the module with a DIN rail or mounting screws. Tighten the screws within the specified torque range. Undertightening can cause drop of the screw, short circuit or malfunction. Overtightening can damage the screw and/or module, resulting in drop, short circuit, or malfunction.
- Shut off the external power supply for the system in all phases before mounting or removing the module to or from the panel. Failure to do so may cause the module to fail or malfunction.
- After the first use of the product, do not mount/remove the terminal block to/from the module more than 50 times. (IEC 61131-2 compliant)
- Before handling the module, touch a grounded metal object to discharge the static electricity from the human body. Failure to do so may cause the module to fail or malfunction.

4

- (1) Tighten the mounting screws of the module within the following ranges.

Screw Location	Tightening Torque Range
Module mounting screw (M4 screw)	0.78 to 1.08N•m
Terminal block terminal screw (M3 screw)	0.59 to 0.88N•m
Terminal block mounting screw (M3.5 screw)	0.68 to 0.98N•m

- (2) A protective film is attached on the module's surface for the purpose of scratch prevention during transportation. Prior to use, be sure to remove it.
- (3) When using the DIN rail adapter, install the DIN rail by making sure of the following:
- (a) Applicable DIN rail models (conforming to the IEC 60715)
    - TH35-7.5Fe
    - TH35-7.5Al
  - (b) DIN rail installation screw interval
 

When installing the DIN rail, tighten the screws with less than 200mm (7.87 inch) pitches.
- (4) When mounting the AJ65SBT-64AD to the DIN rail, press with your finger the centerline of the DIN rail hook at the bottom of the module until it clicks.

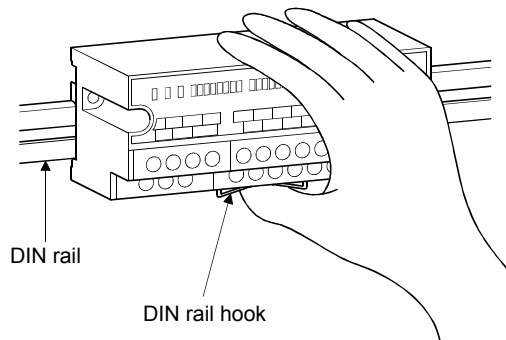

- (5) For the models, specifications, and manufacturers of the cables that can be used for the AJ65SBT-64AD, refer to the user's manual for the master module used.

4.3 Name of Each Part

The name of each part in the AJ65SBT-64AD is shown.

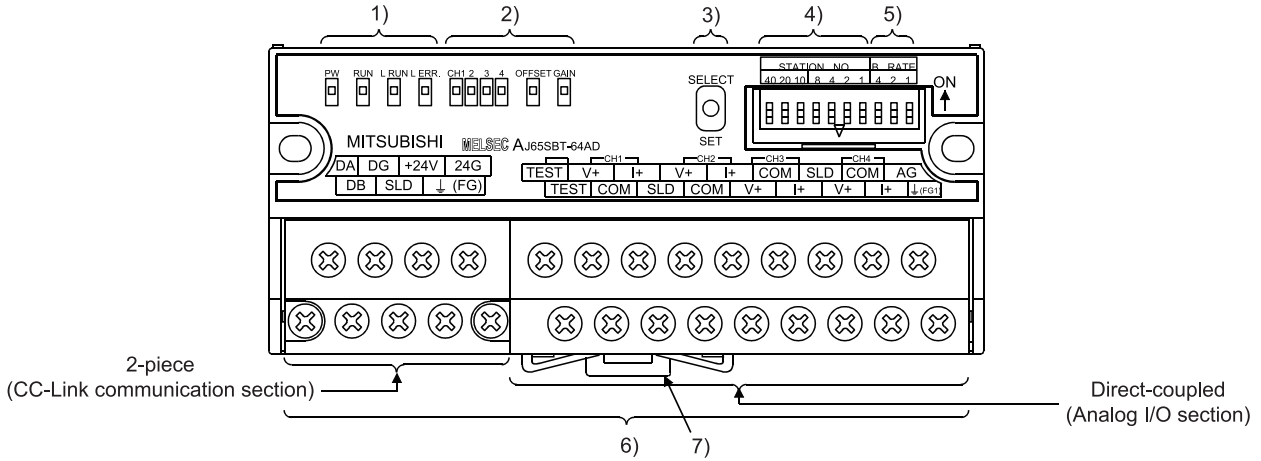

Number	Name and appearance	Description		
1)	Operation status display LED	PW LED	ON : Power supply on OFF: Power supply off	
		RUN LED	Normal mode	On : Normal operation Flashing : 0.1s intervals indicate an input range error. Off : 24VDC power supply shutoff or watchdog timer error occurred.
			Test mode	On : Indicates that the SELECT/SET switch is in the SET position. Flashing : 0.1s intervals indicate that the input range setting is not any of "user range settings 1 to 3". 0.5s intervals indicate that you attempted to make offset/gain setting outside the setting range. Off : Indicates that the SELECT/SET switch is in the SELECT or center position.
		L RUN LED	On : Normal communication Off : Communication cutoff (time expiration error)	
L ERR. LED	On : Indicates that transmission speed setting or station number setting is outside the range. Flicker at fixed intervals : Indicates that transmission speed setting or station number setting was changed from that at power-on. Flicker at unfixed intervals : Indicates that you forgot fitting the termination resistor or the module or CC-Link dedicated cable is affected by noise. Off : Indicates normal communications.			
2)	Offset/gain adjusting LEDs	CH1	Normal mode : Normally OFF.	
		OFFSET GAIN	Test mode : The LEDs lit change every time the SELECT/SET switch is moved to SELECT. (Refer to Section 4.4.)	
3)	SELECT/SET switch	Used to make offset/gain setting in the test mode.		

Number	Name and appearance	Description																																																																																																														
4)	Station number setting switches	<p>Use the switches in STATION NO. "10", "20" and "40" to set the tens of the station number.                      Use the switches in STATION NO. "1", "2", "4" and "8" to set the units of the station number.                      The switches are all factory-set to OFF.                      Always set the station number within the range 1 to 64.                      Setting any other number than 1 to 64 will result in an error, flickering the "L ERR." LED.                      You cannot set the same station number to two or more stations.</p> <table border="1" data-bbox="499 506 1412 857"> <thead> <tr> <th rowspan="2">Station number</th> <th colspan="3">Tens</th> <th colspan="4">Units</th> </tr> <tr> <th>40</th> <th>20</th> <th>10</th> <th>8</th> <th>4</th> <th>2</th> <th>1</th> </tr> </thead> <tbody> <tr><td>1</td><td>OFF</td><td>OFF</td><td>OFF</td><td>OFF</td><td>OFF</td><td>OFF</td><td>ON</td></tr> <tr><td>2</td><td>OFF</td><td>OFF</td><td>OFF</td><td>OFF</td><td>OFF</td><td>ON</td><td>OFF</td></tr> <tr><td>3</td><td>OFF</td><td>OFF</td><td>OFF</td><td>OFF</td><td>OFF</td><td>ON</td><td>ON</td></tr> <tr><td>4</td><td>OFF</td><td>OFF</td><td>OFF</td><td>OFF</td><td>ON</td><td>OFF</td><td>OFF</td></tr> <tr><td>:</td><td>:</td><td>:</td><td>:</td><td>:</td><td>:</td><td>:</td><td>:</td></tr> <tr><td>10</td><td>OFF</td><td>OFF</td><td>ON</td><td>OFF</td><td>OFF</td><td>OFF</td><td>OFF</td></tr> <tr><td>11</td><td>OFF</td><td>OFF</td><td>ON</td><td>OFF</td><td>OFF</td><td>OFF</td><td>ON</td></tr> <tr><td>:</td><td>:</td><td>:</td><td>:</td><td>:</td><td>:</td><td>:</td><td>:</td></tr> <tr><td>64</td><td>ON</td><td>ON</td><td>OFF</td><td>OFF</td><td>ON</td><td>OFF</td><td>OFF</td></tr> </tbody> </table> <p>(Example) To set the station number to "32", set the switches as indicated below.</p> <table border="1" data-bbox="499 922 1412 1021"> <thead> <tr> <th rowspan="2">Station number</th> <th colspan="3">Tens</th> <th colspan="4">Units</th> </tr> <tr> <th>40</th> <th>20</th> <th>10</th> <th>8</th> <th>4</th> <th>2</th> <th>1</th> </tr> </thead> <tbody> <tr><td>32</td><td>OFF</td><td>ON</td><td>ON</td><td>OFF</td><td>OFF</td><td>ON</td><td>OFF</td></tr> </tbody> </table>	Station number	Tens			Units				40	20	10	8	4	2	1	1	OFF	OFF	OFF	OFF	OFF	OFF	ON	2	OFF	OFF	OFF	OFF	OFF	ON	OFF	3	OFF	OFF	OFF	OFF	OFF	ON	ON	4	OFF	OFF	OFF	OFF	ON	OFF	OFF	:	:	:	:	:	:	:	:	10	OFF	OFF	ON	OFF	OFF	OFF	OFF	11	OFF	OFF	ON	OFF	OFF	OFF	ON	:	:	:	:	:	:	:	:	64	ON	ON	OFF	OFF	ON	OFF	OFF	Station number	Tens			Units				40	20	10	8	4	2	1	32	OFF	ON	ON	OFF	OFF	ON	OFF
Station number	Tens			Units																																																																																																												
	40	20	10	8	4	2	1																																																																																																									
1	OFF	OFF	OFF	OFF	OFF	OFF	ON																																																																																																									
2	OFF	OFF	OFF	OFF	OFF	ON	OFF																																																																																																									
3	OFF	OFF	OFF	OFF	OFF	ON	ON																																																																																																									
4	OFF	OFF	OFF	OFF	ON	OFF	OFF																																																																																																									
:	:	:	:	:	:	:	:																																																																																																									
10	OFF	OFF	ON	OFF	OFF	OFF	OFF																																																																																																									
11	OFF	OFF	ON	OFF	OFF	OFF	ON																																																																																																									
:	:	:	:	:	:	:	:																																																																																																									
64	ON	ON	OFF	OFF	ON	OFF	OFF																																																																																																									
Station number	Tens			Units																																																																																																												
	40	20	10	8	4	2	1																																																																																																									
32	OFF	ON	ON	OFF	OFF	ON	OFF																																																																																																									
5)	Transmission speed setting switches	<table border="1" data-bbox="499 1086 1412 1308"> <thead> <tr> <th rowspan="2">Set value</th> <th colspan="3">Setting switches</th> <th rowspan="2">Transmission speed</th> </tr> <tr> <th>4</th> <th>2</th> <th>1</th> </tr> </thead> <tbody> <tr><td>0</td><td>OFF</td><td>OFF</td><td>OFF</td><td>156kbps</td></tr> <tr><td>1</td><td>OFF</td><td>OFF</td><td>ON</td><td>625kbps</td></tr> <tr><td>2</td><td>OFF</td><td>ON</td><td>OFF</td><td>2.5Mbps</td></tr> <tr><td>3</td><td>OFF</td><td>ON</td><td>ON</td><td>5.0Mbps</td></tr> <tr><td>4</td><td>ON</td><td>OFF</td><td>OFF</td><td>10Mbps</td></tr> </tbody> </table> <p>Always set the transmission speed within the above range.                      The switches are all factory-set to OFF.                      Making any other setting than the above will result in an error, flickering the "L ERR." LED.</p>	Set value	Setting switches			Transmission speed	4	2	1	0	OFF	OFF	OFF	156kbps	1	OFF	OFF	ON	625kbps	2	OFF	ON	OFF	2.5Mbps	3	OFF	ON	ON	5.0Mbps	4	ON	OFF	OFF	10Mbps																																																																													
Set value	Setting switches			Transmission speed																																																																																																												
	4	2	1																																																																																																													
0	OFF	OFF	OFF	156kbps																																																																																																												
1	OFF	OFF	ON	625kbps																																																																																																												
2	OFF	ON	OFF	2.5Mbps																																																																																																												
3	OFF	ON	ON	5.0Mbps																																																																																																												
4	ON	OFF	OFF	10Mbps																																																																																																												
6)	Terminal block	Used to connect the module power supply, transmission and I/O signals.																																																																																																														
7)	DIN rail hook	Used to mount the module to the DIN rail.																																																																																																														

4.4 Offset/Gain Setting

When changing the I/O conversion characteristics, follow the procedure below.

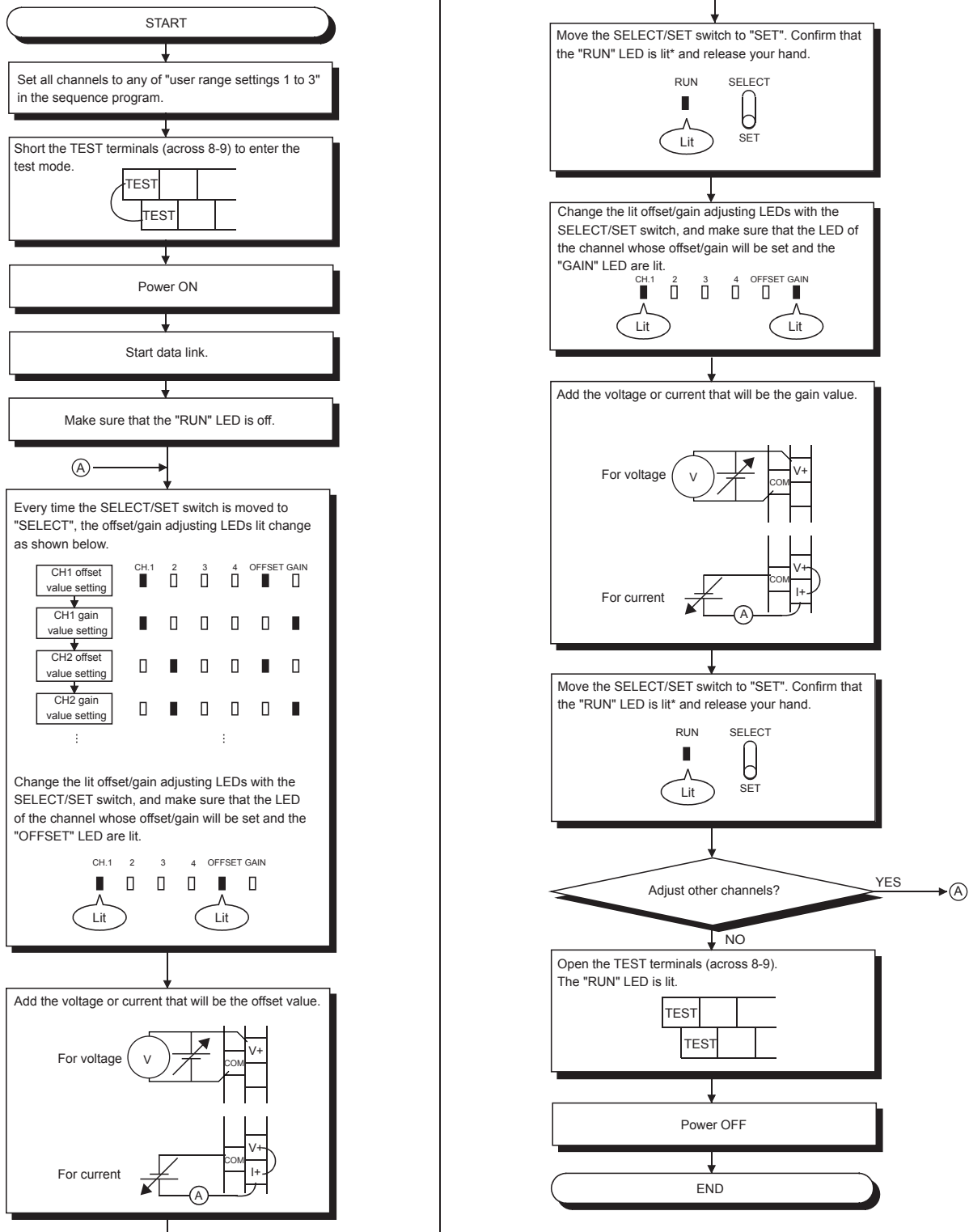

POINT
<p>(1) Set the offset and gain values in the actual usage state.</p> <p>(2) The offset and gain values are stored on E2PROM in the AJ65SBT-64AD and are not cleared at power-off.</p> <p>(3) Shorting the TEST terminals to enter the test mode and executing initial settings will start A/D conversion on all channels. To judge the test mode, use the test mode flag as an interlock.</p> <p>(4) Make offset/gain setting within the range indicated in POINT of Section 3.3.1 and Section 3.3.2. If setting is made outside this range, the maximum resolution/accuracy may not fall within the performance specifications range.</p> <p>(5) When making offset/gain setting (in the test mode), set all channels to any of "user range settings 1 to 3". Setting any other range will result in an error and flicker the "RUN" LED at 0.1s intervals. Refer to Section 3.6.3 for input range setting.</p> <p>(6) When the grounding indicated in Section 4.8.2 *5 is changed (not performed → perform, or performed to removed), repeat the offset/gain setting from the start.</p>



### 4.5 Station Number Setting

The station number setting of the AJ65SBT-64AD determines the buffer memory addresses of the master module where the remote I/O signals and read/write data are stored.

For details, refer to the user's manual for the master module used.

### 4.6 Facing Direction of the Module Installation

The AJ65SBT-64AD module may be installed in any of six directions.

(There are no restrictions on the facing directions.)

Also, a DIN rail may be used for installation.

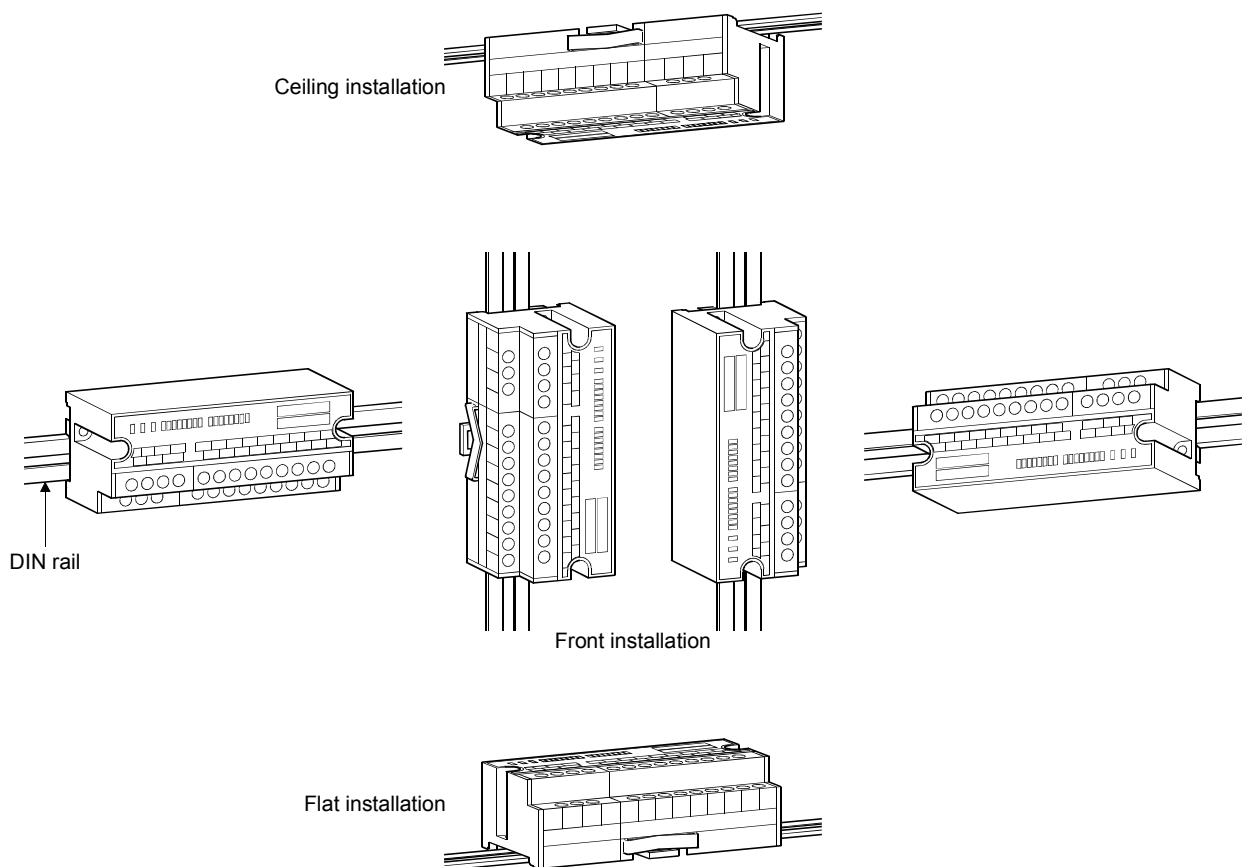

4.7 Data Link Cable Wiring

This section explains the wiring of the CC-Link dedicated cable used for connection of the AJ65SBT-64AD and master module.

4.7.1 Connection of the CC-Link dedicated cables

Connect the CC-Link dedicated cable between the AJ65SBT-64AD and master module as shown below.

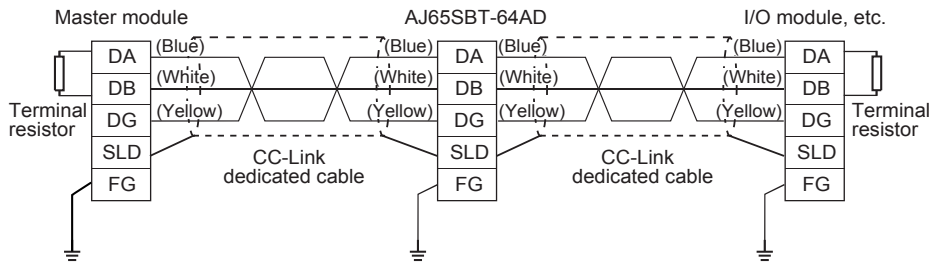

## 4.8 Wiring

This section provides the instructions for wiring the AJ65SBT-64AD and its wiring with external equipment.

### 4.8.1 Wiring precautions

To obtain maximum performance from the functions of AJ65SBT-64AD and improve the system reliability, an external wiring with high durability against noise is required. The precautions when performing external wiring are as follows:

- (1) Use separate cables for the AC and AJ65SBT-64AD external input signals, in order not to be affected by the AC side surge or conductivity.
- (2) Do not bundle or place with load carrying wires other than the main circuit line, high voltage line or programmable controller. Noises, surges, or conductivity may affect the system.
- (3) Place a one-point grounding on the programmable controller side for the shielded line or shielded cable. However, depending on the external noise conditions, it may be better have a grounding externally.

### 4.8.2 Module connection example

(1) For voltage input

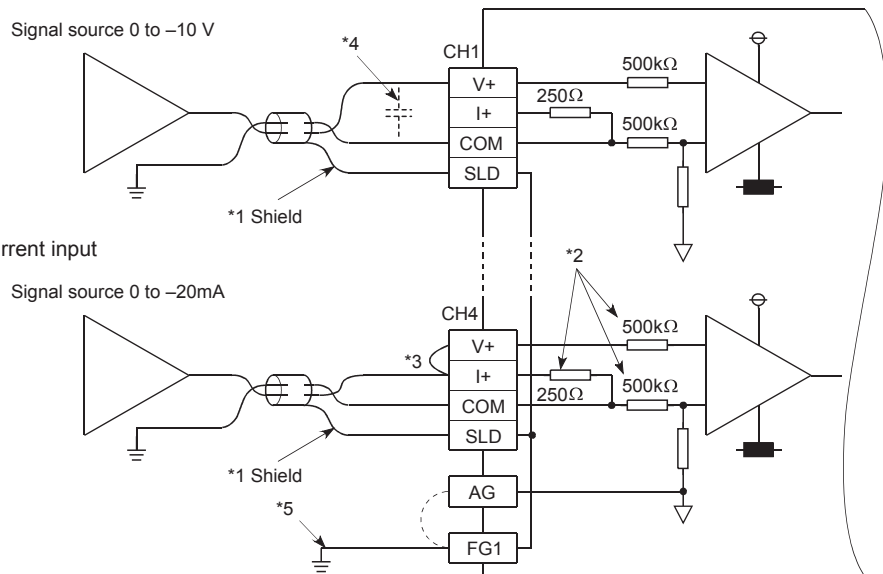

- \*1 Use a two-core twisted shield line for the power cable.
  - \*2 Indicates the AJ65SBT-64AD input resistor.
  - \*3 For the current input, be sure to connect the (V+) and (I+) terminals.
  - \*4 When noise or ripple occurs with the external cable, connect a condenser with about 0.1 to 0.47μF (25V or higher voltage-resistant product) between the terminal V and COM.
  - \*5 Always perform grounding for FG1. When there is a lot of noise, it may be better ground AG as well.
- If the grounding wiring (grounding yes/no) is changed after the offset and gain are set, perform the setting of the offset/gain values again.

POINT
<ul style="list-style-type: none"><li>• A/D conversion values are fluctuated by self-heating within approx. 30 minutes after power is turned ON.</li><li>• In an unused channel, if terminals remain open, an erratic digital value may be output. To prevent this, take any of the following measures.<ol style="list-style-type: none"><li>1. Select Prohibit in the A/D conversion enable/prohibit setting for the unused channel. Note that changing the setting from Enable to Prohibit will reduce the sampling cycle.</li><li>2. Short-circuit the input terminals (terminal V+ and COM) of the unused channel.</li><li>3. Connect the AG terminal to the GND terminal of the external device.</li></ol></li></ul>



#### 4.9 Maintenance and Inspection

There are no special inspection items for the AJ65SBT-64AD module, but follow the inspections items describes in the programmable controller CPU User's Manual so that the system can always be used in the best condition.

## 5 PROGRAMMING

The programming procedure, basic read/write programs, and program examples for the AJ65SBT-64AD are described.

When utilizing the program example introduced in this chapter for an actual system, fully verify that there are no problems in controllability in the target system.

This chapter describes examples when a QCPU, QnACPU, or ACPU is used as a CPU module and GX Developer is used as a programming tool. For the case when a LCPU is used as a CPU module or GX Works2 is used as a programming tool, refer to the user's manual for the master module used.

In addition, for details on a master module and dedicated instructions described in each program example, refer to the user's manual for the master module used and Type AnSHCPU/AnACPU/AnUCPU/QCPU-A (A Mode) Programming Manual (Dedicated Instructions) respectively.

### 5.1 Programming Procedure

Create a program which executes the AJ65SBT-64AD analog/digital conversion by following the procedure below:

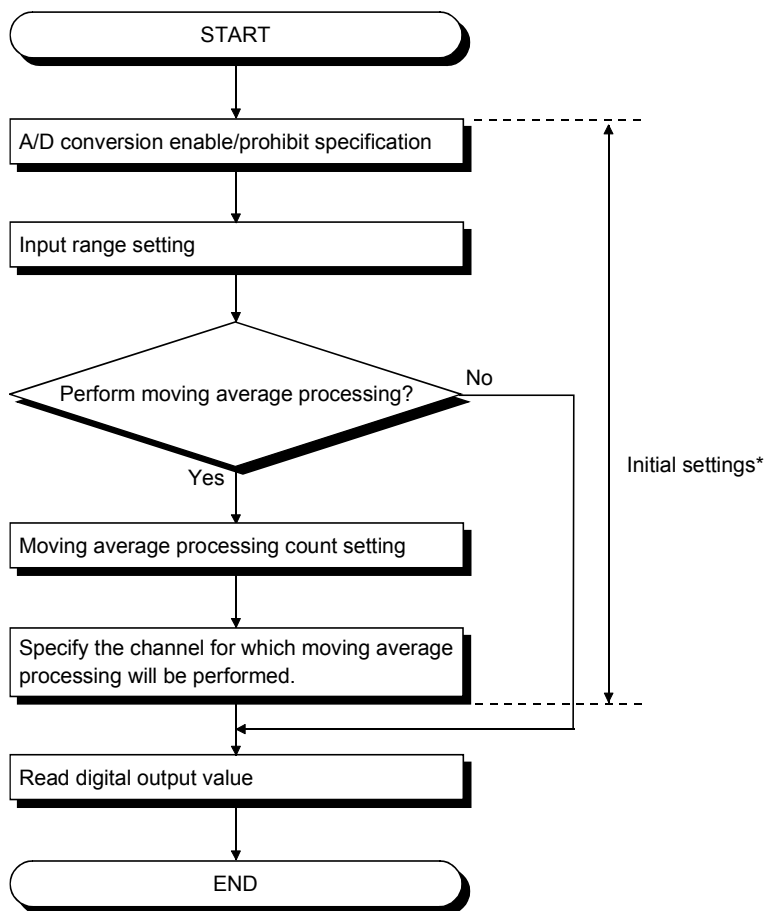

\* When using the QCPU (Q mode), you can use the remote device station initialization procedure registration function to make settings. When using the ACPU, QCPU (A mode) or QnACPU, use the sequence program to make settings.

5.2 Conditions of Program Example

The program examples in this chapter are created under the following conditions.

(1) System configuration

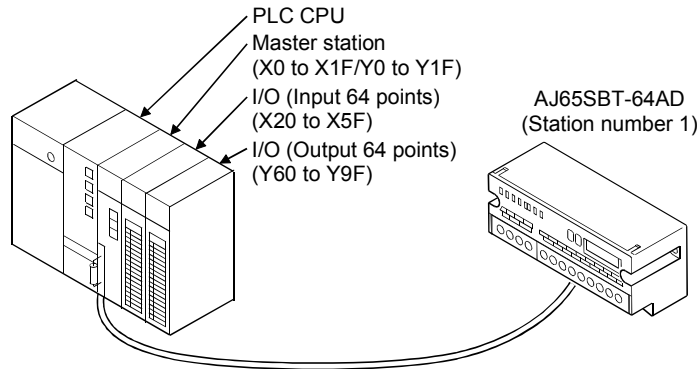

(2) Relationships between programmable controller CPU, master module and AJ65SBT-64AD

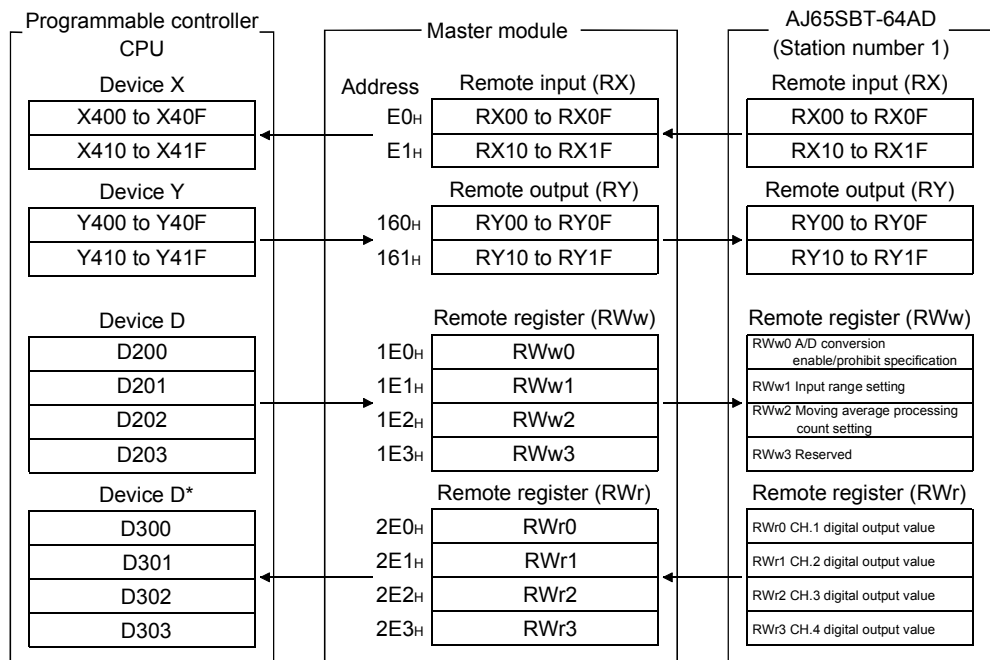

\* In the program example (refer to Section 5.5) that uses the RRPA instruction (automatic refresh parameter setting) with the ACPUCPU (A mode), RWr0 to RWr3 are assigned to D456 to D459.

**POINT**

Some CPU modules may not accept the devices used in the program example in this chapter. For the setting ranges of the devices, refer to the user's manual of the CPU module used.

For an A1SCPU, for example, devices X100 and Y100 or later cannot be used. Use devices such as B and M.

## (3) Initial settings

Setting Item	Settings
A/D conversion enable/prohibit specification (RWw0)	A/D conversion enabled channel: Channel 1, 2
Input range setting (RWw1)	Channel 1: 0 to 5V Channel 2: User range setting 1
Moving average processing count setting (RWw2)	Number of moving average processing times of channel 2: 16 times
CH.1 moving average processing specifying flag (RY00)	Channel 1: Sampling processing
CH.2 moving average processing specifying (RY01)	Channel 2: Moving average processing

5.3 Program Example for Use of the QCPU (Q mode)

The program examples in this section are created under the following conditions. GX Developer is used to set the network and automatic refresh parameters. Using the remote device station initialization procedure registration function facilitates initial settings.

(1) Parameter setting

(a) Network parameter setting

	1
Start I/O No	0000
Operational setting	Operational settings
Type	Master station
Master station data link type	PLC parameter auto start
Mode	Remote net(Ver.1 mode)
All connect count	1
Remote input(RX)	
Remote output(RY)	
Remote register(RW/r)	
Remote register(RW/w)	
Ver.2 Remote input(RX)	
Ver.2 Remote output(RY)	
Ver.2 Remote register(RW/r)	
Ver.2 Remote register(RW/w)	
Special relay(SB)	
Special register(SW)	
Retrv count	3
Automatic reconnection station count	1
Stand by master station No.	
PLC down select	Stop
Scan mode setting	Asynchronous
Delay information setting	0
Station information setting	Station information
Remote device station initial setting	Initial settings
Interrupt setting	Interrupt settings

Station No.	Station type	Expanded cyclic setting	Exclusive station count	Remote station points	Reserve/invalid station select	Intelligent buffer select(word)	Send	Receive	Automatic
1/1	Remote device station	single	Exclusive station 1	32 points	No setting				

(b) Automatic refresh parameter setting

	1
Start I/O No	0000
Operational setting	Operational settings
Type	Master station
Master station data link type	PLC parameter auto start
Mode	Remote net(Ver.1 mode)
All connect count	1
Remote input(RX)	X400
Remote output(RY)	Y400
Remote register(RW/r)	D300
Remote register(RW/w)	D200
Ver.2 Remote input(RX)	
Ver.2 Remote output(RY)	
Ver.2 Remote register(RW/r)	
Ver.2 Remote register(RW/w)	
Special relay(SB)	SB0
Special register(SW)	SW0
Retrv count	3
Automatic reconnection station count	1
Stand by master station No.	
PLC down select	Stop
Scan mode setting	Asynchronous
Delay information setting	0
Station information setting	Station information
Remote device station initial setting	Initial settings
Interrupt setting	Interrupt settings



(2) Initial setting by remote device station initialization procedure registration

(a) Setting the target station number

Set the station number to which initial setting will be made.

Set the target station number to "1".

Remote device station initial setting: Target station number setting: Module 1							
	Target station No.	No. of registered procedures			Target station No.	No. of registered procedures	
	1	1	Regist procedure	9			Regist procedure
	2		Regist procedure	10			Regist procedure

(b) Setting the procedure registration

When the initial data processing request flag (RX18) turns on and the remote device station initialization procedure registration (SB0D) is set, the following data are registered to the AJ65SBT-64AD.

Procedure Execution Condition	Execution
Initial data processing request flag (RX18) turns on	A/D conversion enable/prohibit specification: channels 1, 2: enable (RWw0: 0003H)
	Input range setting : channel 1: 0 to 5V : channel 2: user range setting 1 (RWw1: 51H)
	Moving average processing count setting: channel 2: 16 times (RWw5: 10H)
	CH.1 moving average processing specifying flag: sampling processing (RY00: OFF)
	CH.2 moving average processing specifying flag: moving average processing (RY01: ON)
	Initial data processing completion flag (RY18) is turned on.
Initial data processing request flag (RX18) turns off	Initial data processing completion flag (RY18) is turned off.
Initial data setting completion flag (RX19) turns on	Initial data setting request flag (RY19) is turned off.

(c) Setting results

The setting results are shown below.

Remote device station initial setting: Procedure registration module 1: Target station 1							
Input format <input type="text" value="HEX"/>							
Execute Flag	Operational condition	Executorial condition			Details of execution		
		Condition Device	Device Number	Execute Condition	Write Device	Device Number	Write Data
Execute	Set new	RX	18	ON	RWw	00	0003
Execute	Same as prev.set	RX	18	ON	RWw	01	0051
Execute	Same as prev.set	RX	18	ON	RWw	02	0020
Execute	Same as prev.set	RX	18	ON	RY	00	OFF
Execute	Same as prev.set	RX	18	ON	RY	01	ON
Execute	Same as prev.set	RX	18	ON	RY	18	ON
Execute	Same as prev.set	RX	18	ON	RY	19	ON
Execute	Set new	RX	18	OFF	RY	18	OFF
Execute	Set new	RX	19	ON	RY	19	OFF

(3) Program example

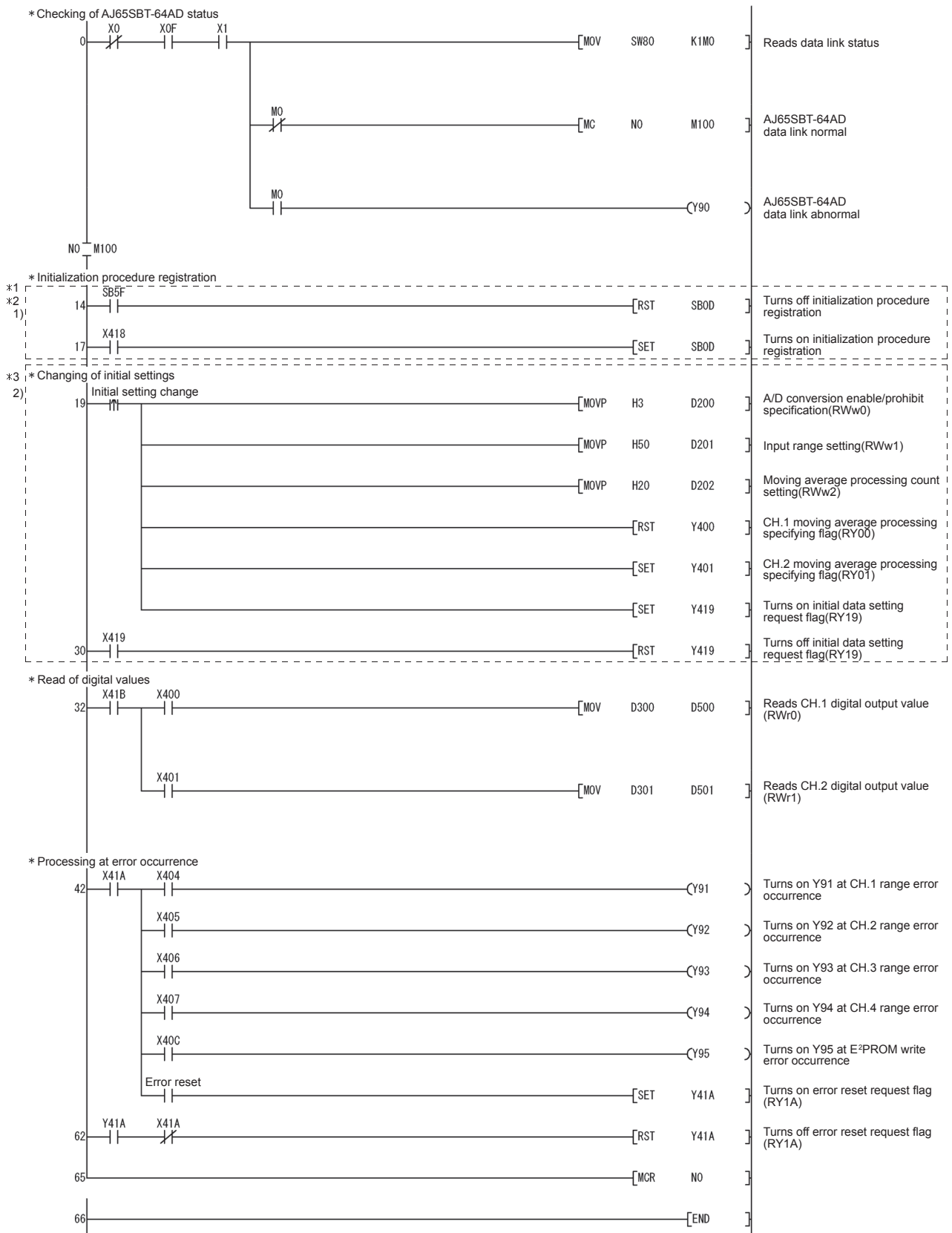

\*1 Before the communication program is executed with remote device stations, the program enclosed by the dotted line 1) enables the initial setting by using the SB0D (remote device station initialization procedure registration instruction) and SB5F (completion status of remote device station initialization procedure). Initialization processing cannot be executed only by setting parameters of GX Developer.

\*2 When multiple remote device stations are used, correct the program enclosed by the dotted line 1) as shown below.

[System configuration]

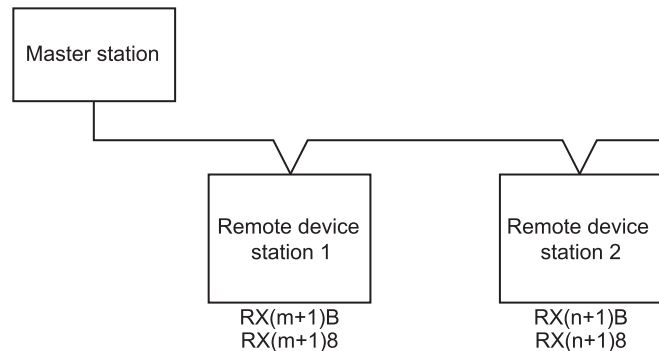

[Corrected program]



- RX(m+1)B and RX(n+1)B are remote READY.
- RX(m+1)8 and RX(n+1)8 are initial data processing request flags.

Insert the remote READY and initial data processing request flags for all the stations, to which the remote device station initialization procedure registration has been made, into the program as an interlock.

If the following modules are used as remote device stations, configure initial settings of these stations using a sequence program.

- AJ65BT-64AD analog-digital converter module
- AJ65BT-68TD thermocouple temperature input module
- AJ65BT-64RD3 platinum temperature-measuring resistor Pt100 temperature input module
- AJ65BT-64RD4 platinum temperature-measuring resistor Pt100 temperature input module

The above corrected program does not apply to these stations because the condition where the remote READY turns on differs between the AJ65SBT-64AD and these remote device stations.

\*3 The program enclosed by the dotted line 2) is necessary only when the initial settings are changed.

5.4 Program Example for Use of the QnACPU

GX Developer is used to set the network and automatic refresh parameters.

(1) Parameter setting

(a) Network parameter setting

Start I/O No.	1
Type	0000
Type	Master station
All connect count	1
Remote input[RX]	
Remote output[RY]	
Remote register[RW/r]	
Remote register[RW/w]	
Special relay[SB]	
Special register[SW]	
Retry count	3
Automatic reconnection station count	1
Wait master station No.	0
PLC down select	Stop
Scan mode setting	Asynchronously
Delay information setting	0
Station information setting	Station information

StationNo.	Station type	Exclusive station count	Reserve/invalid station select	Intelligent buffer select[word]		
				Send	Receive	Automatic
1/1	Remote device station	Exclusive station 1	No setting			

(b) Automatic refresh parameter setting

Start I/O No.	1
Type	0000
Type	Master station
All connect count	1
Remote input[RX]	X400
Remote output[RY]	Y400
Remote register[RW/r]	D300
Remote register[RW/w]	D200
Special relay[SB]	B0
Special register[SW]	w0
Retry count	3
Automatic reconnection station count	1
Wait master station No.	0
PLC down select	Stop
Scan mode setting	Asynchronously
Delay information setting	0
Station information setting	Station information

(2) Program example

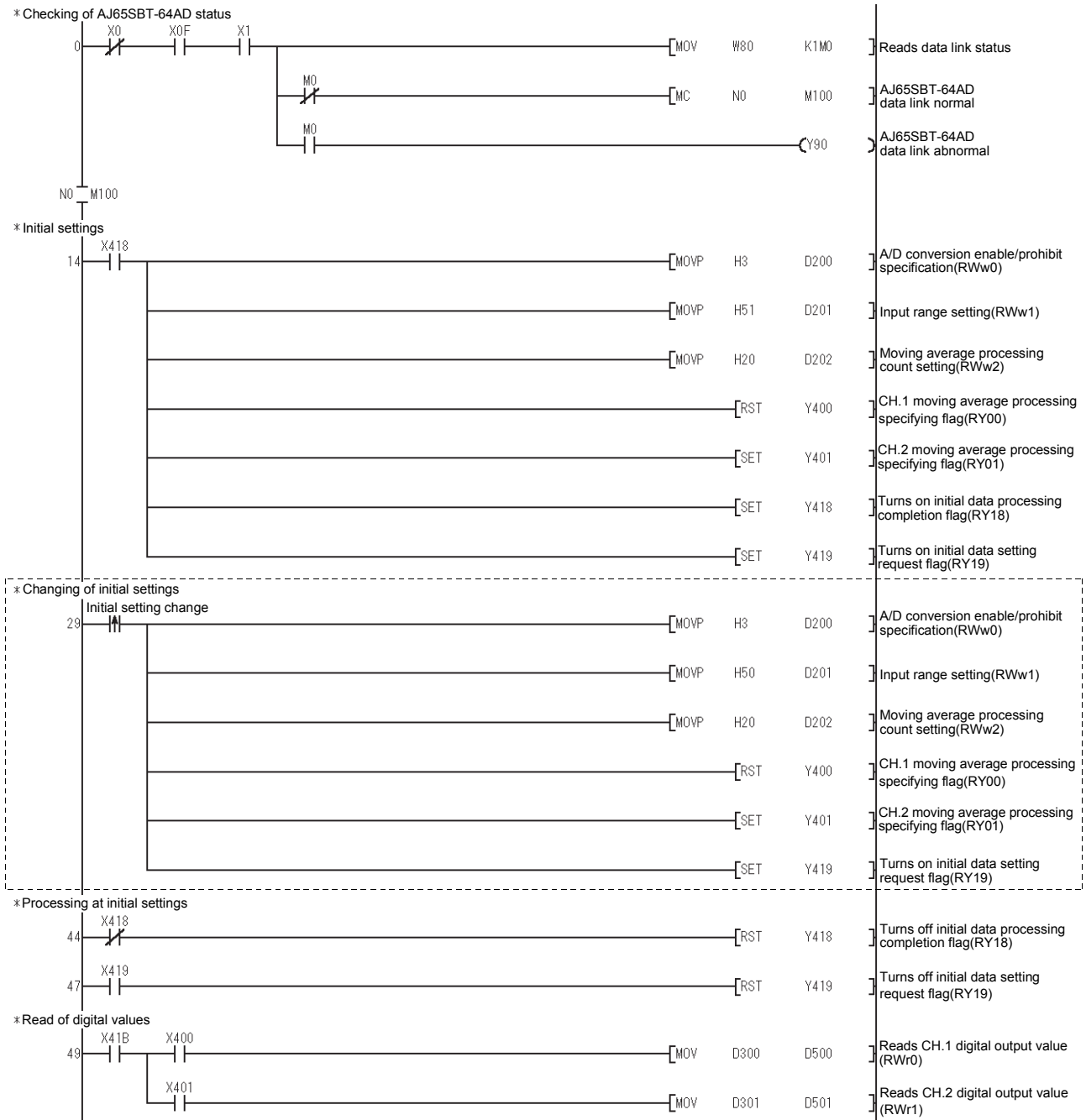

\* The program enclosed by the dotted line is necessary only when the initial settings are changed.

\* Processing at error occurrence



5.5 Program Example for Use of the ACPU/QCPU (A mode) (dedicated instructions)

A sequence program is used to set the network and automatic refresh parameters.

(1) Program example

\* Setting of network parameters using RLPA dedicated instruction

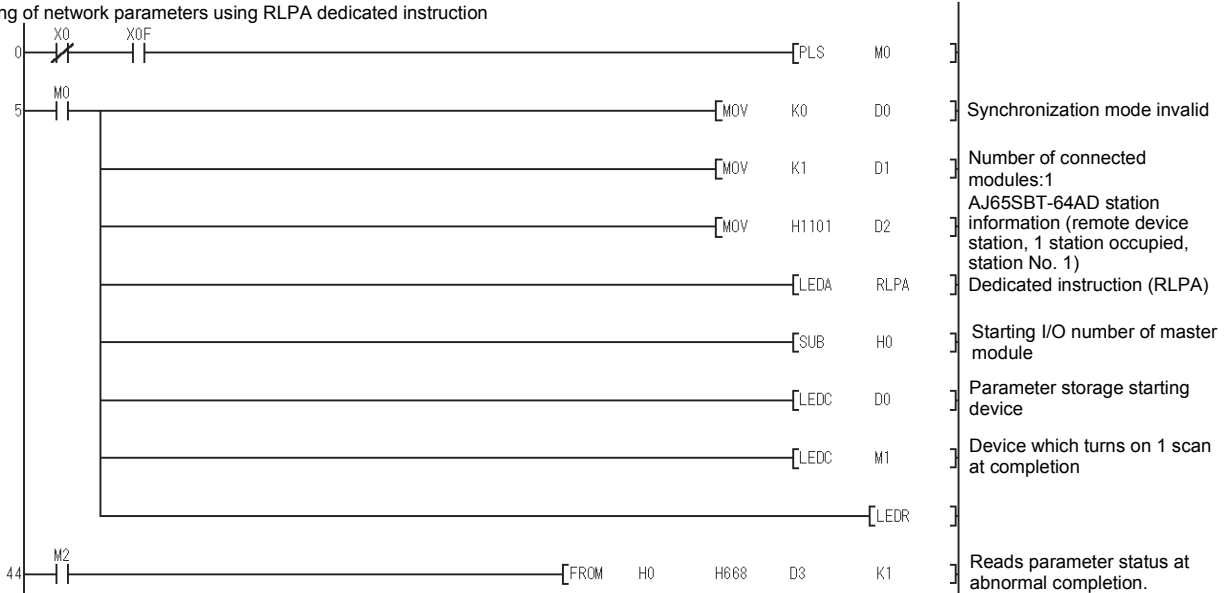

\* Setting of automatic refresh parameters using RRPA dedicated instruction

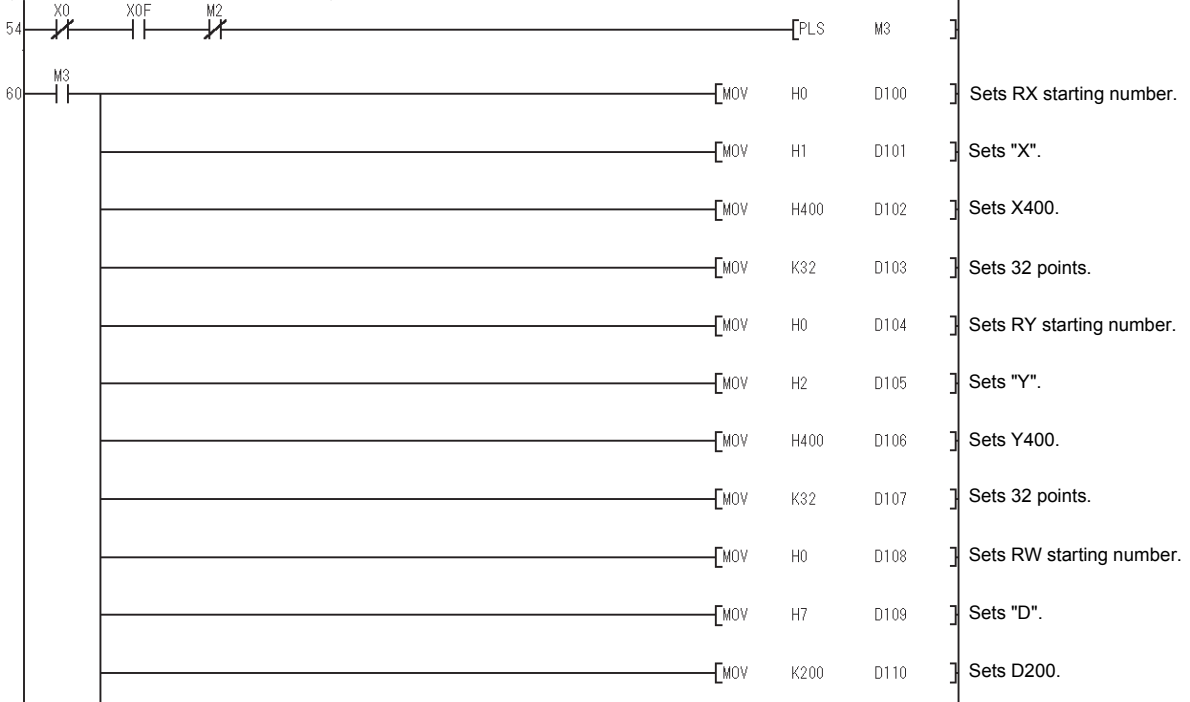

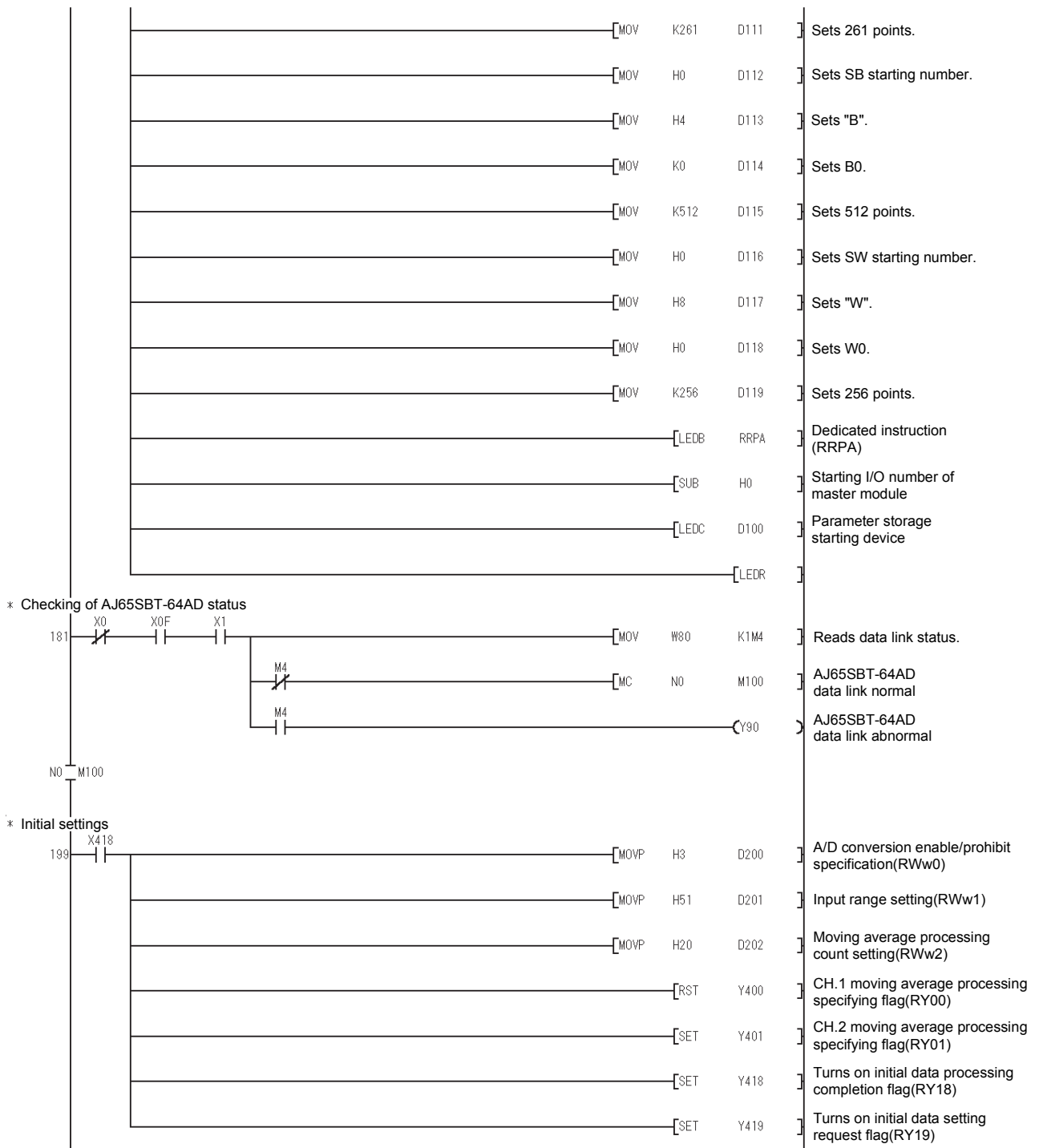



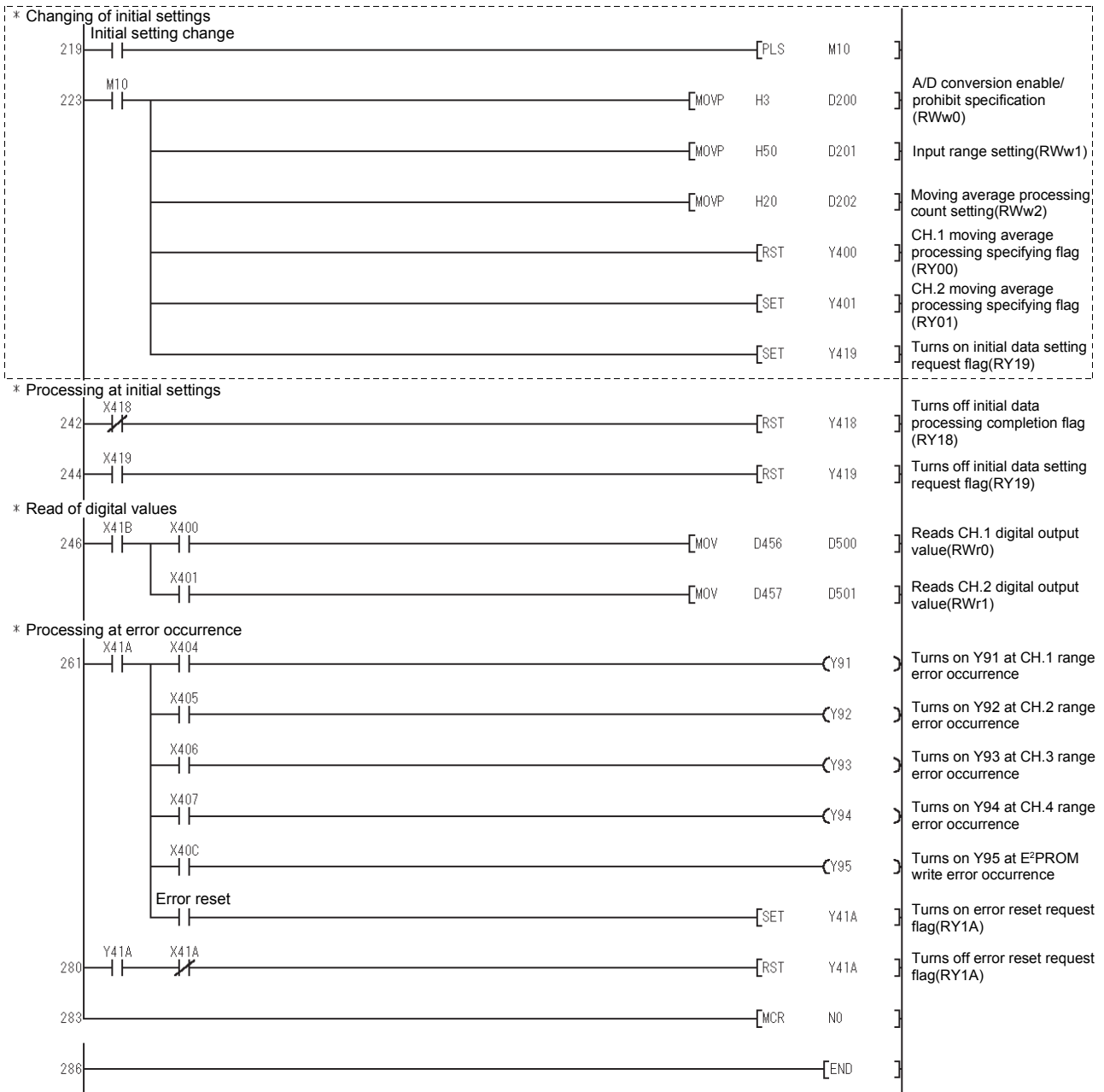

\* The program enclosed by the dotted line is necessary only when the initial settings are changed.

5.6 Program Example for Use of the ACPU/QCPU (A mode) (FROM/TO instructions)

A sequence program is used to set the network parameters.

(1) Program example

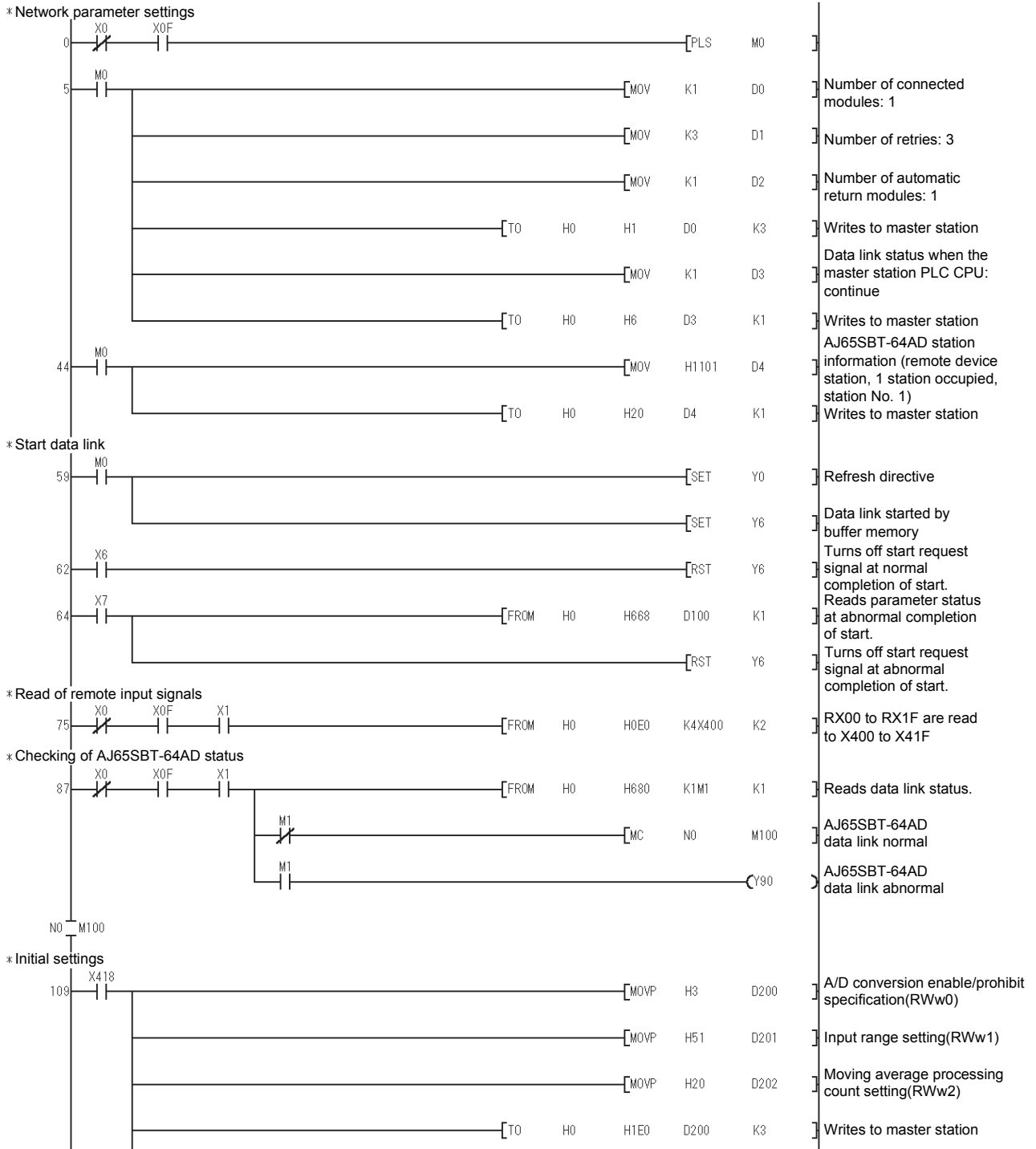

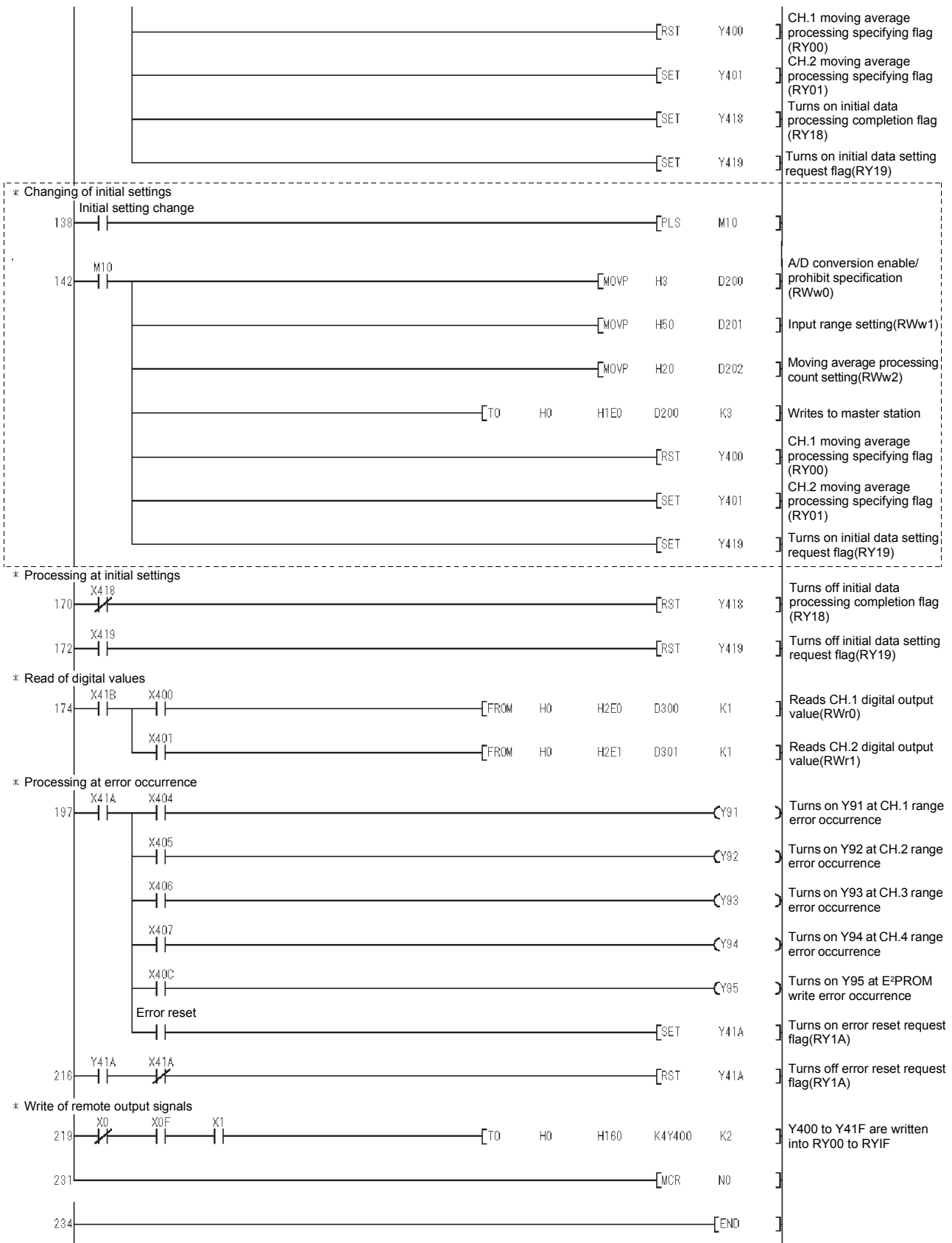

\* The program enclosed by the dotted line is necessary only when the initial settings are changed.



## 6 TROUBLESHOOTING

The details of the errors which may occur when using the AJ65SBT-64AD and troubleshooting are described.

### 6.1 Using the Remote Input Signals to Check Errors

In the AJ65SBT-64AD, occurrence of a write error turns on any of the following remote input signals.

Device No.	Signal Name	Description
RXn4	CH.1 range error flag	Turns on when the value set for input range setting is outside the setting range. Turns on if all channels are not set to any of "user range settings 1 to 3" at offset/gain setting (in the test mode).
RXn5	CH.2 range error flag	
RXn6	CH.3 range error flag	
RXn7	CH.4 range error flag	
RXnC	E <sup>2</sup> PROM write error flag	Turns on if value write failed due to excess of the E <sup>2</sup> PROM write count over its limit at the time of offset/gain setting. If this flag has turned on, this module itself has failed (hardware fault) and therefore this flag cannot be reset (turned off) by the error reset request flag.
RX(n+1)A	Error status flag	Turns on when CH. <input type="checkbox"/> range error flag (RXn4 to RXn7) or E <sup>2</sup> PROM write error flag (RXnC) has turned on. This flag can be reset (turned off) by turning on the error reset request flag. However, for the E <sup>2</sup> PROM write error which cannot be reset, this flag cannot be reset, either.

- (1) For the input range error (RXn4 to RXn7), the "RUN" LED flickers at intervals of 0.1s and A/D conversion is not performed on all channels.
- (2) For the E<sup>2</sup>PROM write error (RXnC), power on the AJ65SBT-64AD again.  
If the E<sup>2</sup>PROM write error (RXnC) turns on after the AJ65SBT-64AD was powered on, a hardware failure might have occurred. Please consult your local Mitsubishi representative.

## 6.2 Using the LED Indications to Check Errors

This section explains how to check errors using the LED indications of the AJ65SBT-64AD.

Refer to the programmable controller CPU and master module user's manual for issues regarding the programmable controller CPU and master module.

### (1) When the AJ65SBT-64AD "PW" LED is off

Check item	Corrective action
Is 24VDC power on?	Check the external power supply.
Is the voltage of the 24VDC power supply within the specified value?	Set the voltage value to within the range 20.4 to 26.4V.

### (2) When the AJ65SBT-64AD "RUN" LED is flashing

Check item	Corrective action
Is the LED flickering at 0.1s intervals in the normal mode?	<ol style="list-style-type: none"> <li>Using the remote input signals (RXn4 to RXn7), check the channel at which the input range setting error has occurred.</li> <li>Make correction to the sequence program or GPPW setting.</li> </ol>
Is the LED flickering at 0.1s intervals in the test mode?	Set all channels to any of "user range settings 1 to 3" in input range setting.
Is the LED flickering at 0.5s intervals in the test mode?	Change the offset/gain adjustment to within the available setting range.

### (3) When the AJ65SBT-64AD "RUN" LED is off

Check item	Corrective action
Has the watchdog timer error occurred?	<p>Using the link special registers (SW0084 to SW0087) of the master module, check the watchdog timer error and power on the AJ65SBT-64AD again.</p> <p>If the "RUN" LED is not lit after the AJ65SBT-64AD was powered on, the possible cause is a hardware failure. Please consult your local Mitsubishi representative.</p>
Has the TEST terminals (across 8-9) been shorted to enter the test mode?	After making offset/gain adjustment, open the TEST terminals (across 8-9).

### (4) When the AJ65SBT-64AD "L RUN" LED is off

Communications are broken.

For details, refer to troubleshooting in the user's manual for the master module used.

(5) When the AJ65SBT-64AD "L ERR." LED flickers at fixed intervals

Check item	Corrective action
Has the station number or transmission speed setting switch position been changed during normal operation?	After correcting the setting switch setting, switch power on again.
Is the station number or transmission speed setting switch faulty?	If the "L ERR." LED has begun flickering without switch setting change during operation, the possible cause is a hardware failure. Please consult your local Mitsubishi representative.

(6) When the AJ65SBT-64AD "L ERR." LED flickers at unfixed intervals

Check item	Corrective action
Have you forgotten fitting the terminal resistor?	Check whether the terminal resistor is fitted. If it is not connected, connect it and switch power on again.
Is the module or CC-Link dedicated cable affected by noise?	Earth both ends of the shield wire of the CC-Link dedicated cable to the protective earth conductor via SLD and FG of the corresponding module. Earth the FG terminal of the module without fail. When carrying out wiring in piping, earth the pipe without fail.

(7) When the AJ65SBT-64AD "L ERR." LED is on

Check item	Corrective action
Are the station number and transmission speed correct?	Set the correct station number and transmission speed.

## 6.3 When the digital output value cannot be read

Check item	Corrective action
Is the "PW" LED off?	Take action as described in Section 6.2 (1).
Is the "RUN" LED flashing or off?	Take action as described in Section 6.2 (2), (3).
Is the "L RUN" LED off?	Take action as described in Section 6.2 (4).
Is the "L ERR." LED on?	Take action as described in Section 6.2 (7). Check the error details by referring to the user's manual for the master module used.
Is the programmable controller CPU "RUN" LED flashing or off?	Check the error details according to the programmable controller CPU user's manual.
Is the master module "RUN" LED off?	Check the error details by referring to the user's manual for the master module used.
Is the master module [RD] [SD] LED on?	Check the error details by referring to the user's manual for the master module used.
Is the analog input signal line disconnected, cut off, or any errors?	Check the error area by checking the signal line visually or by conductive check.
Remove the AJ65SBT-64AD analog input cable. Apply the test voltage (stable power supply or battery) to this module's terminal, and measure the digital output value.	If the AJ65SBT-64AD module digital output value is normal, the effects are being received by noise from an external wiring. So check the wiring and grounding method. Lift the AJ65SBT-64AD from the system, and remove the grounding circuit. (install to the DIN rail.)



6.4 Troubleshooting for the Case where the "ERR." LED of the Master Station Flickers

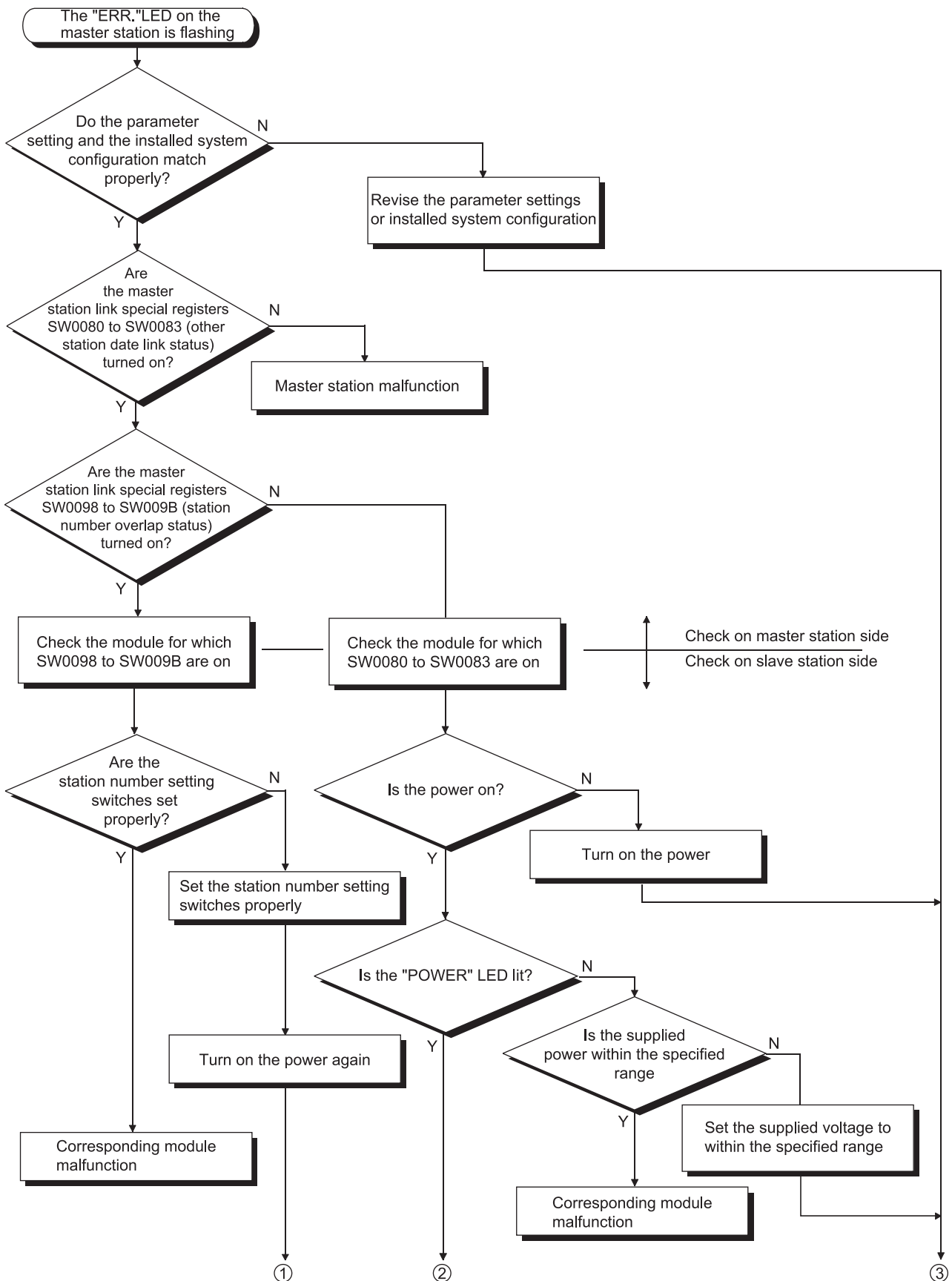

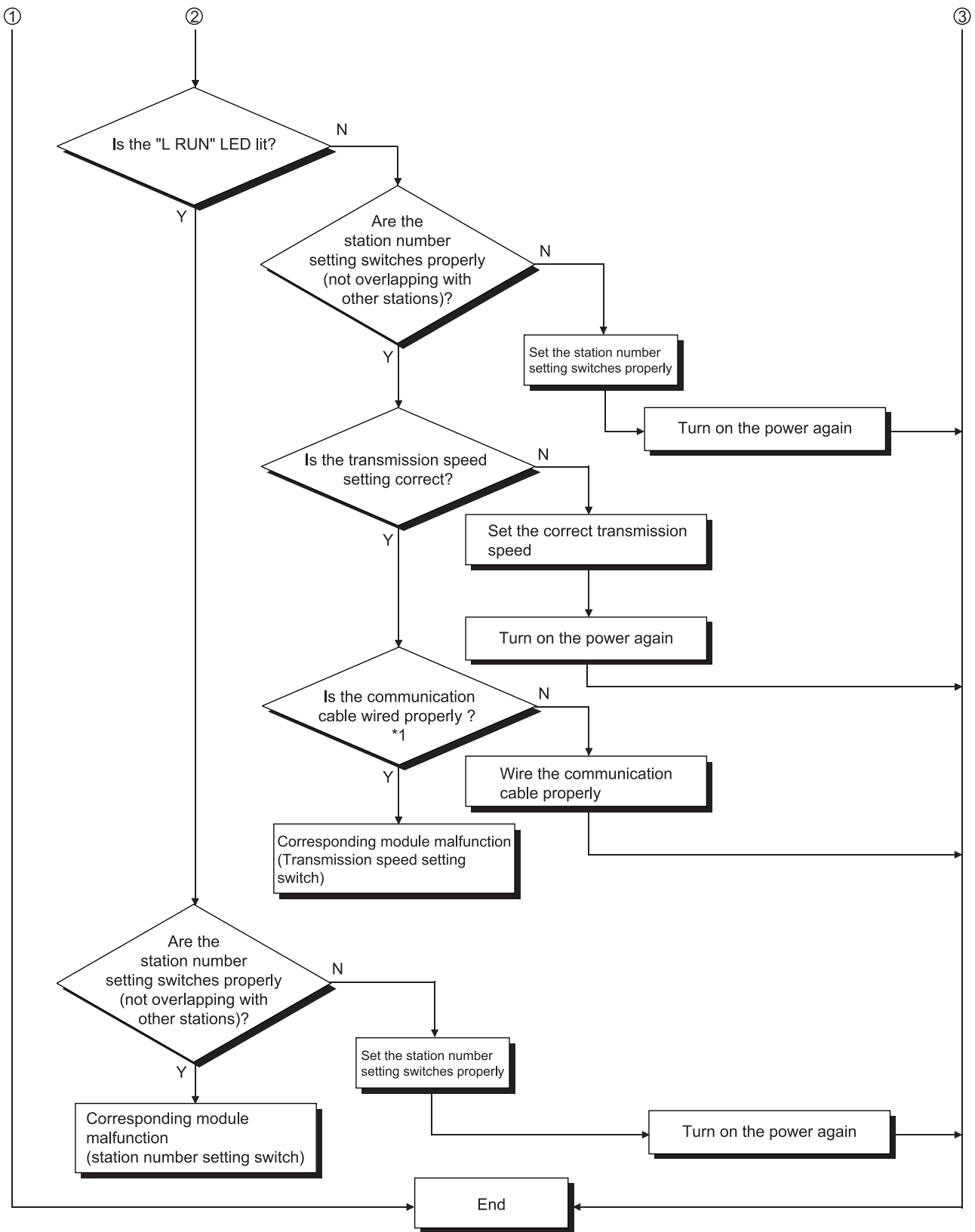

\*1 Check for a short, reversed connection, wire breakage, terminal resistor, FG connection, overall distance and station-to-station distance.

APPENDICES

Appendix 1 Comparison between This Product and Conventional Product

(1) Comparison in performance between this product and conventional product

The following table gives performance comparison between the AJ65SBT-64AD and conventional product (AJ65BT-64AD).

Performance Comparison between AJ65SBT-64AD and Conventional Product

Item		Specifications																																														
		AJ65SBT-64AD	AJ65BT-64AD																																													
Analog input	Voltage	-10 to +10VDC (input resistance: 1MΩ)																																														
	Current	0 to 20mADC (input resistance: 250Ω)																																														
Digital output		-4096 to +4095	-4000 to +4000																																													
I/O characteristics Maximum resolution	Voltage	<table border="1"> <thead> <tr> <th></th> <th>Input Range</th> <th>Digital Output</th> <th>Max. Resolution</th> </tr> </thead> <tbody> <tr> <td rowspan="4">Voltage</td> <td>-10 to +10V</td> <td rowspan="2">-4000 to +4000</td> <td rowspan="2">2.5mV</td> </tr> <tr> <td>User range setting 1 (-10 to +10V)</td> </tr> <tr> <td>0 to 5V</td> <td rowspan="2">0 to 4000</td> <td>1.25mV</td> </tr> <tr> <td>1 to 5V</td> <td>1.0mV</td> </tr> <tr> <td rowspan="3">Current</td> <td>0 to 20mA</td> <td rowspan="3">0 to 4000</td> <td>5μA</td> </tr> <tr> <td>4 to 20mA</td> <td rowspan="2">4μA</td> </tr> <tr> <td>User range setting 3 (0 to 20mA)</td> </tr> </tbody> </table>		Input Range	Digital Output	Max. Resolution	Voltage	-10 to +10V	-4000 to +4000	2.5mV	User range setting 1 (-10 to +10V)	0 to 5V	0 to 4000	1.25mV	1 to 5V	1.0mV	Current	0 to 20mA	0 to 4000	5μA	4 to 20mA	4μA	User range setting 3 (0 to 20mA)	<table border="1"> <thead> <tr> <th></th> <th>Input Range</th> <th>Digital Output</th> <th>Max. Resolution</th> </tr> </thead> <tbody> <tr> <td rowspan="4">Voltage</td> <td>-10 to +10V</td> <td rowspan="4">0 to 4000 or -2000 to +2000</td> <td>5mV</td> </tr> <tr> <td>0 to 10V</td> <td>2.5mV</td> </tr> <tr> <td>0 to 5V</td> <td>1.25mV</td> </tr> <tr> <td>1 to 5V</td> <td>1.0mV</td> </tr> <tr> <td rowspan="4">Current</td> <td>-20 to +20mA</td> <td rowspan="4">0 to 4000 or -2000 to +2000</td> <td>20μA</td> </tr> <tr> <td>0 to 20mA</td> <td>10μA</td> </tr> <tr> <td>0 to 20mA</td> <td>5μA</td> </tr> <tr> <td>4 to 20mA</td> <td>4μA</td> </tr> </tbody> </table>		Input Range	Digital Output	Max. Resolution	Voltage	-10 to +10V	0 to 4000 or -2000 to +2000	5mV	0 to 10V	2.5mV	0 to 5V	1.25mV	1 to 5V	1.0mV	Current	-20 to +20mA	0 to 4000 or -2000 to +2000	20μA	0 to 20mA	10μA	0 to 20mA	5μA	4 to 20mA	4μA
		Input Range	Digital Output	Max. Resolution																																												
Voltage	-10 to +10V	-4000 to +4000	2.5mV																																													
	User range setting 1 (-10 to +10V)																																															
	0 to 5V	0 to 4000	1.25mV																																													
	1 to 5V		1.0mV																																													
Current	0 to 20mA	0 to 4000	5μA																																													
	4 to 20mA		4μA																																													
	User range setting 3 (0 to 20mA)																																															
	Input Range	Digital Output	Max. Resolution																																													
Voltage	-10 to +10V	0 to 4000 or -2000 to +2000	5mV																																													
	0 to 10V		2.5mV																																													
	0 to 5V		1.25mV																																													
	1 to 5V		1.0mV																																													
Current	-20 to +20mA	0 to 4000 or -2000 to +2000	20μA																																													
	0 to 20mA		10μA																																													
	0 to 20mA		5μA																																													
	4 to 20mA		4μA																																													
Input range changing		Per channel	All channels in batch																																													
Offset/gain setting		Yes																																														
Accuracy	Ambient temperature 0 to 55°C	±0.4% (accuracy relative to maximum value of digital output value)	±1.0% (accuracy relative to maximum value of digital output value)																																													
	Ambient temperature 25±5°C	±0.2% (accuracy relative to maximum value of digital output value)	_____																																													
Max. conversion speed		1ms/channel																																														
Absolute max. input		Voltage ±15V, current ±30mA	Voltage ±15V, current ±30mA																																													
Number of analog input points		4 channels/module																																														
Number of occupied I/O points		1 station occupied (RX/Ry: 32 points each, RWr/RWw: 4 points each)	2 stations occupied (RX/Ry: 32 points each, RWr/RWw: 8 points each)																																													
Connected terminal block		7-point, 2-piece terminal block (transmission, power supply) Direct-coupled, 18-point terminal block (analog input section) (M3 screw)	27-point terminal block (M3.5 screw)																																													
Applicable wire size		0.3 to 0.75mm <sup>2</sup>																																														
Applicable crimping terminal		RAV1.25-3																																														
24VDC internal current consumption		0.090A																																														
Weight		0.20kg																																														
Outline dimensions		118mm(W) × 50mm(H) × 40mm(D)																																														
		151.9mm(W) × 65mm(H) × 63mm(D)																																														



(2) Precautions for replacing the conventional product (AJ65BT-64AD) with the AJ65SBT-64AD

In the existing system using the conventional product (AJ65BT-64AD), the following instructions must be noted when changing the AJ65BT-64AD for the AJ65SBT-64AD.

- (a) Since the AJ65SBT-64AD occupies one station (the AJ65BT-64AD occupies two stations), the station information setting in the network parameters must be changed.
- (b) As the remote I/O signals and remote register settings are different between the two models, the program of the conventional model cannot be utilized.
- (c) Because of the differences in shape and layout between the terminal blocks, you cannot use the terminal block of the conventional module as it is.
- (d) The offset/gain setting method differs. For details, refer to Section 4.4.
- (e) The ways to set the station number and transmission speed setting switches are different. For details, refer to Section 4.3.

Appendix 2 External Dimensions

The external dimensions of the AJ65SBT-64AD are shown below.

The appearance of the AJ65SBT-64AD varies depending on the hardware version or serial number.

For checking method of the hardware version, refer to Section 2.3.

For checking method of the serial number, refer to Section 2.4.

(1) Hardware version of F or later or serial number (first five digits) of "16041" or later

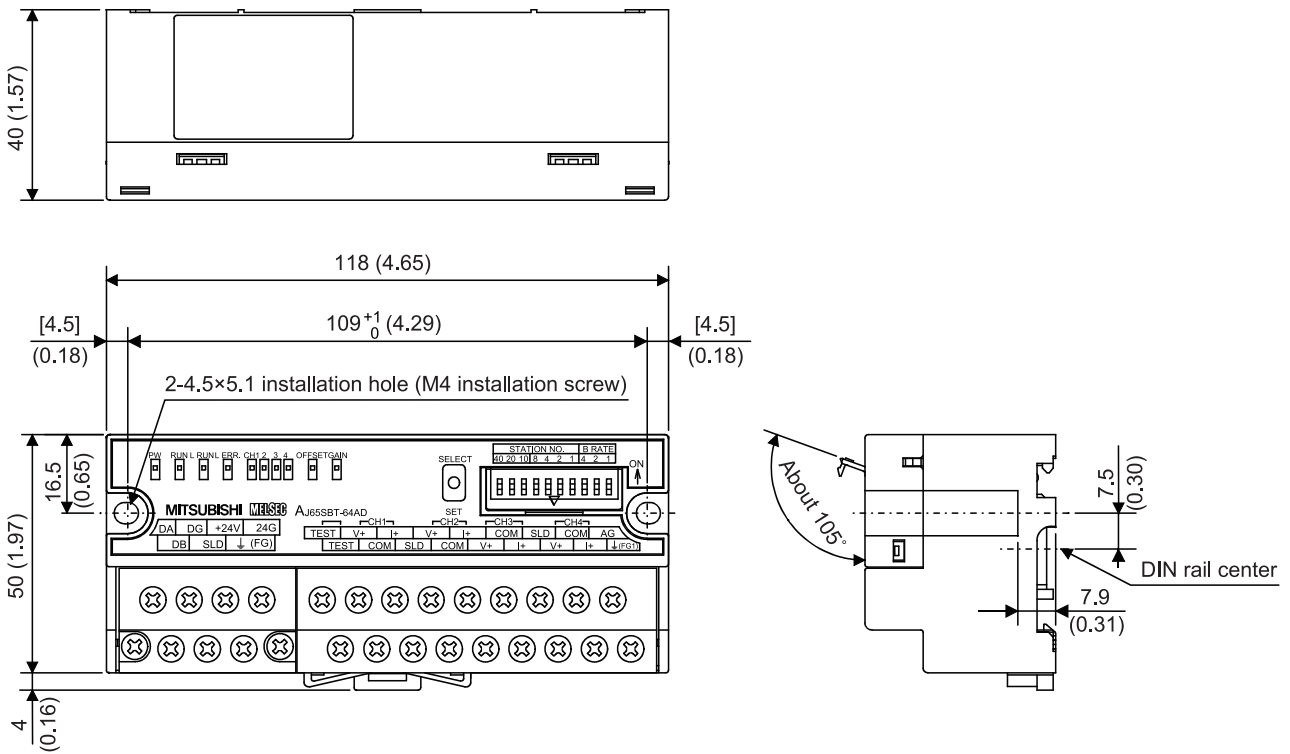

Unit: mm (inch)

(2) Hardware version E or earlier

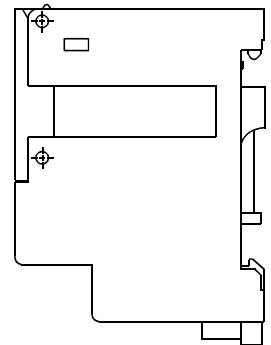
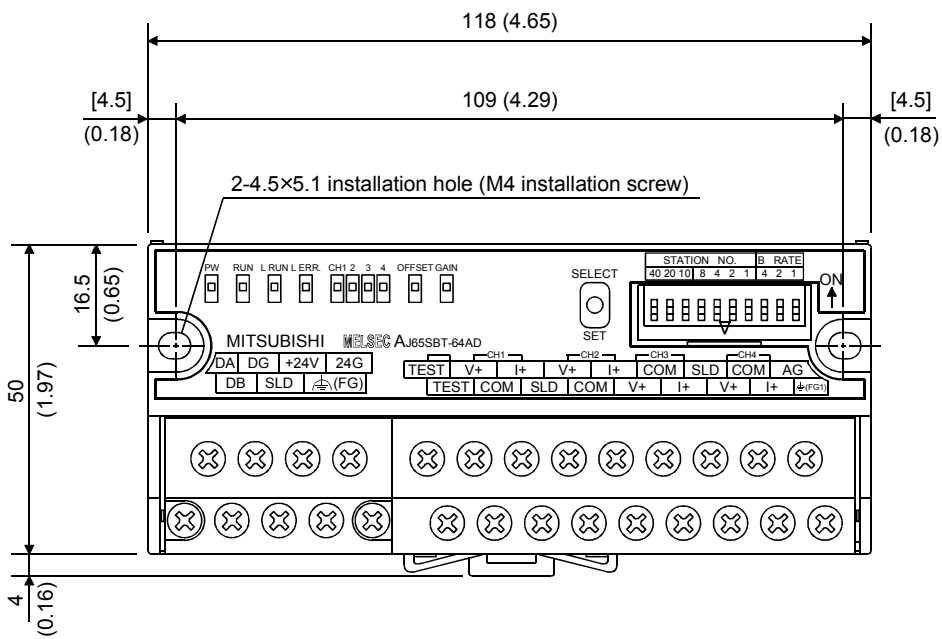
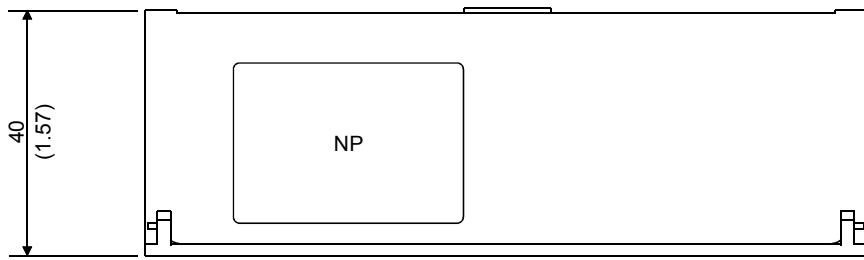

Unit: mm (inch)

## INDEX

- [A]  
 A/D conversion completion flag ..... 3-11  
 A/D conversion enable/prohibit specification  
 ..... 3-14  
 Absolute maximum input..... 3-2  
 Accuracy..... 3-2,3-6  
 Analog input..... 3-2  
 Analog input points..... 3-2  
 Applicable master modules..... 2-2
- [C]  
 CC-Link dedicated cable..... 4-8  
 CC-Link dedicated instruction..... 2-3  
 Conversion speed ..... 3-7  
 Current consumption..... 3-2  
 Current input characteristics ..... 3-5
- [D]  
 Data link cable wiring ..... 4-8  
 Digital output..... 3-2  
 Digital output value..... 3-16  
 DIN rail..... 3-2,4-2,4-4
- [E]  
 E<sup>2</sup>PROM write error flag ..... 3-11  
 Error reset request flag ..... 3-12  
 Error status flag ..... 3-12  
 External dimensions..... App-3  
 External power supply..... 4-2
- [F]  
 Facing direction of the module installation .... 4-7  
 Function list ..... 3-8
- [G]  
 Gain value ..... 3-4  
 General specification..... 3-1
- [I]  
 I/O Conversion Characteristics ..... 3-3  
 Initial data processing completion flag ..... 3-12  
 Initial data processing request flag ..... 3-11  
 Initial data setting completion flag..... 3-11  
 Initial data setting request flag ..... 3-12  
 Input range changing function ..... 3-8  
 Input range setting ..... 3-15  
 Input range setting error ..... 6-2
- [M]  
 Maintenance and inspection..... 4-10  
 Maximum resolution..... 3-2,3-6  
 Module connection example..... 4-9  
 Moving average processing ..... 3-9  
 Moving average processing count setting .... 3-16  
 Moving average processing specifying flag .. 3-12
- [N]  
 Name of each part ..... 4-3  
 Number of occupied stations..... 3-2
- [O]  
 Offset value ..... 3-3  
 Offset/gain adjusting LED..... 4-3  
 Offset/Gain Setting..... 4-5  
 Operation status display LED..... 4-3
- [P]  
 Performance comparison between AJ65SBT-64AD and conventional product ..... App-1  
 Performance specification ..... 3-2  
 Pre-Operation procedure ..... 4-1  
 Precautions for replacing the conventional product (AJ65BT-64AD) with the AJ65SBT-64AD ..... App-2  
 Precautions when handling ..... 4-1  
 Program example for use of the QCPU (Q mode) ..... 5-4  
 Program example for use of the QnACPU ..... 5-8  
 Program example for use of the ACPU/QCPU (A mode) (dedicated instructions) ..... 5-11  
 Program example for use of the ACPU/QCPU (A mode) (FROM/TO instructions) ..... 5-14  
 Programming procedure..... 5-1
- [R]  
 Range error flag ..... 3-11,6-1  
 Remote I/O signal list..... 3-10  
 Remote READY ..... 3-12  
 Remote register allocation..... 3-13  
 Resolution ..... 3-6

[S]	
Sampling processing.....	3-9
SELECT/SET switch .....	4-3
Station number setting switch.....	4-4
[T]	
Terminal block .....	3-2,4-4
Terminal number .....	4-3
Test mode flag.....	3-11
Tightening torque range.....	4-2
Troubleshooting.....	6-1
Troubleshooting for the case where the "ERR."LED of the master station flickers .....	6-5
[U]	
User range setting .....	3-4,3-5
[V]	
Voltage input characteristics .....	3-4
[W]	
Weight.....	3-2
Wiring.....	4-9





# WARRANTY

Please confirm the following product warranty details before using this product.

## 1. Gratis Warranty Term and Gratis Warranty Range

If any faults or defects (hereinafter "Failure") found to be the responsibility of Mitsubishi occurs during use of the product within the gratis warranty term, the product shall be repaired at no cost via the sales representative or Mitsubishi Service Company.

However, if repairs are required onsite at domestic or overseas location, expenses to send an engineer will be solely at the customer's discretion. Mitsubishi shall not be held responsible for any re-commissioning, maintenance, or testing on-site that involves replacement of the failed module.

### **[Gratis Warranty Term]**

The gratis warranty term of the product shall be for one year after the date of purchase or delivery to a designated place.

Note that after manufacture and shipment from Mitsubishi, the maximum distribution period shall be six (6) months, and the longest gratis warranty term after manufacturing shall be eighteen (18) months. The gratis warranty term of repair parts shall not exceed the gratis warranty term before repairs.

### **[Gratis Warranty Range]**

- (1) The range shall be limited to normal use within the usage state, usage methods and usage environment, etc., which follow the conditions and precautions, etc., given in the instruction manual, user's manual and caution labels on the product.
- (2) Even within the gratis warranty term, repairs shall be charged for in the following cases.
  1. Failure occurring from inappropriate storage or handling, carelessness or negligence by the user. Failure caused by the user's hardware or software design.
  2. Failure caused by unapproved modifications, etc., to the product by the user.
  3. When the Mitsubishi product is assembled into a user's device, Failure that could have been avoided if functions or structures, judged as necessary in the legal safety measures the user's device is subject to or as necessary by industry standards, had been provided.
  4. Failure that could have been avoided if consumable parts (battery, backlight, fuse, etc.) designated in the instruction manual had been correctly serviced or replaced.
  5. Failure caused by external irresistible forces such as fires or abnormal voltages, and Failure caused by force majeure such as earthquakes, lightning, wind and water damage.
  6. Failure caused by reasons unpredictable by scientific technology standards at time of shipment from Mitsubishi.
  7. Any other failure found not to be the responsibility of Mitsubishi or that admitted not to be so by the user.

## 2. Onerous repair term after discontinuation of production

- (1) Mitsubishi shall accept onerous product repairs for seven (7) years after production of the product is discontinued. Discontinuation of production shall be notified with Mitsubishi Technical Bulletins, etc.
- (2) Product supply (including repair parts) is not available after production is discontinued.

## 3. Overseas service

Overseas, repairs shall be accepted by Mitsubishi's local overseas FA Center. Note that the repair conditions at each FA Center may differ.

## 4. Exclusion of loss in opportunity and secondary loss from warranty liability

Regardless of the gratis warranty term, Mitsubishi shall not be liable for compensation of damages caused by any cause found not to be the responsibility of Mitsubishi, loss in opportunity, lost profits incurred to the user by Failures of Mitsubishi products, special damages and secondary damages whether foreseeable or not, compensation for accidents, and compensation for damages to products other than Mitsubishi products, replacement by the user, maintenance of on-site equipment, start-up test run and other tasks.

## 5. Changes in product specifications

The specifications given in the catalogs, manuals or technical documents are subject to change without prior notice.



SH(NA)-080106-G(1410)MEE

MODEL: AJ65S-64AD-U-S-E

MODEL CODE: 13JR18

## **MITSUBISHI ELECTRIC CORPORATION**

HEAD OFFICE : TOKYO BUILDING, 2-7-3 MARUNOUCHI, CHIYODA-KU, TOKYO 100-8310, JAPAN  
NAGOYA WORKS : 1-14, YADA-MINAMI 5-CHOME, HIGASHI-KU, NAGOYA, JAPAN

When exported from Japan, this manual does not require application to the  
Ministry of Economy, Trade and Industry for service transaction permission.

Specifications subject to change without notice.